

**NC-2400 READER/PUNCH
INSTALLATION AND
OPERATION MANUAL**

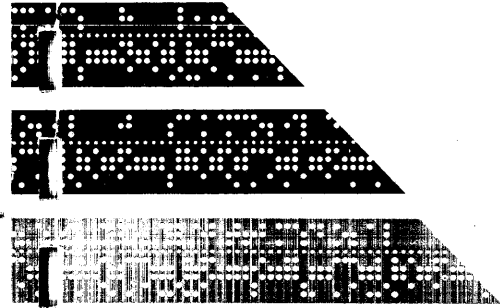

DATA SPECIALTIES, INC.

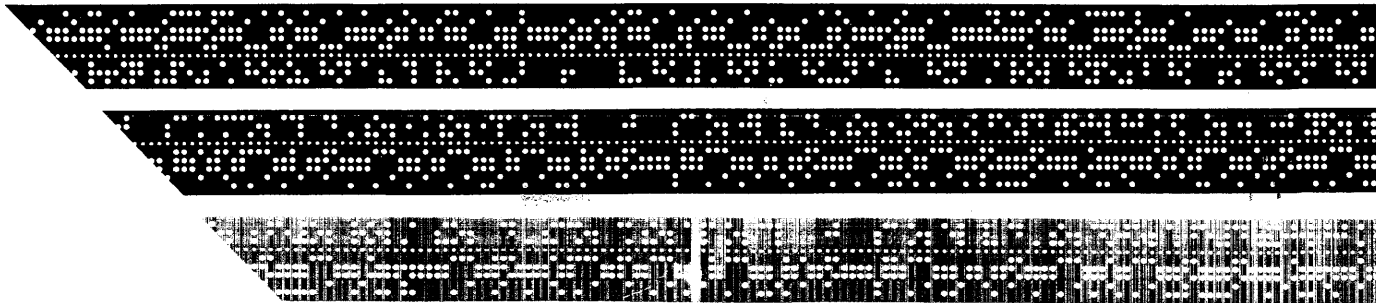

**NC-2400 READER/PUNCH
INSTALLATION AND
OPERATION MANUAL**

IMPORTANT - This manual supports Software Version V1.4 and up.

PROPRIETARY STATEMENT:

This manual contains proprietary information of Data Specialties, Inc. It is intended solely for the information and use of parties operating and maintaining the equipment described herein. Such proprietary information may not be used, reproduced, or disclosed to any other parties for any other purpose without the expressed written permission of Data Specialties, Inc.

LIABILITY DISCLAIMER:

Data Specialties, Inc. takes steps to assure that its published Engineering Specifications and Manuals are correct; however, errors do occur. DSI reserves the right to correct any such errors and disclaims liability resulting therefrom.

Data Specialties, Inc.
~~3455 Commercial Ave.~~
Northbrook, IL USA 60062
708 (312) 564-1800
Telex - 206230
1983 Data Specialties, Inc.

NC-2400 READER/PUNCH INSTALLATION AND OPERATION MANUAL

TABLE OF CONTENTS

	PAGE
1. INTRODUCTION	
1.1 Scope	1-1
1.2 General Description	1-2
1.3 Equipment supplied	1-3
1.4 Supplies/Accessories/Upgrade Kit	1-4
2. INSTALLATION	
2.1 Unpacking	2-1
2.2 Storing and shipping	2-1
2.3 Site Requirements	2-2
2.4 Model Identification	2-2
2.5 Power Interface	2-2
2.6 Signal Interface	2-4
2.7 Carriage Return Delay	2-5
2.8 Description of Options	
2.8.1 F-Punch Only, No Reader	2-5
2.8.2 X-Ruggedized	2-6
2.8.3 H-4070 parallel and TTY Current Loop	2-6
2.8.4 T-TTY Current Loop	2-7
2.8.5 B-One Line Buffer (Editing)	2-7
2.8.6 E-In Memory Editing	2-8
2.8.7 J-100/200 VAC	2-10
2.8.8 M-5 Level	2-10
2.9 Under Cover DIP Switch Settings	2-11
2.9.1 Default States	2-11
2.9.2 Basic Settings	2-13
2.9.3 Option Settings	2-14

3.	OPERATING GUIDE	PAGE
3.1	Tape Loading	3-1
3.2	Tearing Off Tape	3-2
3.3	Controls and Indicators	3-2
3.4	Self-diagnostic Checks	3-6
3.5	Tape Reader	3-8
3.6	Tape Orientation/Bit Assignment	3-9
3.7	Tape Perforator	3-9
3.8	Typical Applications	3-10
3.9	Operator Care	3-11

APPENDIX:

A	Recommended Tape Materials	A-1
B	Tape Spacing Standards/Adjustments	B-1
C	ASCII Code Chart and Tape Sample	C-1
D	Interface; RS-232, Terminal	D-1
E	Interface; RS-232, Modem	E-1
F	Interface; Current Loop (Option H or T)	F-1
G	Interface; FACIT 4070 Parallel (Option H)	G-1
H	Interface; RS-232, Printer (Option E)	H-1
J	Interface; Parallel, Printer (Option E)	J-1
K	Interface; RS-491, NC unit to punch	K-1

NC-2400 READER/PUNCH INSTALLATION AND OPERATION MANUAL

1. INTRODUCTION

1.1 SCOPE

This manual is a guide to the simple procedures required to install and operate your NC-2400. It applies to the basic unit as well as units with one or more of the following options:

- Option P: Punch only, without reader.
- Option X: "Ruggedized" version with air filter and carrying handle.
- Option H: 4070 parallel plus TTY current loop interface
- Option T: TTY current loop interface
- Option B:* On-line buffer for editing capability (System I)
- Option E:* In-memory Editing (System II)
- Option J: 100/200VAC in lieu of standard 115/230VAC
- Option M: 5 level 1200/75 baud operation

*The operational characteristics of these two options are described in the User's Guide of the System I and the System II respectively.

For detailed service and maintenance information please order NC-2400 MAINTENANCE MANUAL and DSI Specification No. 3402L.

1.2 GENERAL DESCRIPTION

Data Specialties, Inc. (DSI), is a leading manufacturer of equipment for numerical control, tape preparation, and time-sharing. Designing and manufacturing its own equipment, DSI has produced over 25,000 punches in operation around the world. And now DSI has applied its technology to design the NC-2400.

The NC-2400 is a state-of-the-art microprocessor-based reader/punch combo. It features an up to 75 cps punch, up to 2400 baud reader, operator-selectable baud rates, and dual-ported RS-232C interface.

The NC-2400 has all the on-board intelligence and interface flexibility needed to prepare tapes off-line, to connect on-line to time-share networks, to connect to a remote in-house computer, to down-load to a CNC, or to punch programs edited in a CNC's memory. Most standard CRTs, miniprinters, teleprinters, and computers are compatible with the NC-2400. Dip switches are used to control baud rates, stop bits, XON/XOFF control, CR delay, and data paths.

The device is ergonomically designed for user ease. The control panel is tilted for easy reading while standing or sitting. Color coded sealed membrane switches easily identify switch functions and prevent contamination.

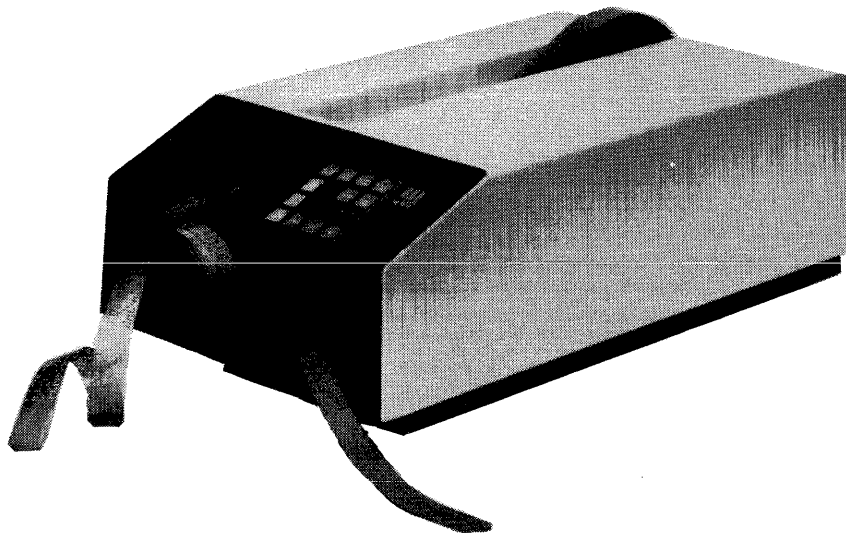

NC-2400

FIGURE 1-1

1.2 GENERAL DESCRIPTION, cont.

The reader is mounted up front for easy loading and operator convenience. It has a 400 foot capacity tape bin as well as the facility to run loop tapes of any length.

The NC-2400 is the only perforated tape peripheral that is built like a computer peripheral. Its stylish, compact case is made of 1/4-inch thick NORYL[®] structural foam, rugged enough for shop or military environments. The NC-2400 is designed to meet the standards set by the FCC, UL, and CSA for computer peripheral equipment.

The heart of all DSI punches is the MODUPERF[®] punch mechanism, with a die block rated at 2,000,000 feet (paper tape) or 500,000 feet (Mylar tape). Accuracy is assured, even with slippery tapes, by the stepper-motor-driven sprocket-wheel advance. The toughest tapes are reliably perforated by the positive push-pull action of the punch pins, making the mechanism virtually jamproof, thus eliminating a major source of downtime. The precision die blocks are interchangeable and field replaceable in just minutes, with no adjustments.

The NC-2400 is expandable in its features and capabilities. It can be used as the first building block in DSI's Series of Tape Preparation Systems.

1.3 EQUIPMENT SUPPLIED

The standard NC-2400 reader/punch comes with a chad box, dust cover, a tape core, this manual, and in the U.S. and Canada, an AC power cord. Tape is not supplied with the unit. See Section 1.4 for tape supplies, spare fuses, and other helpful accessory items you may need.

1.4 SUPPLIES/ACCESSORIES/UPGRADE KITS

Following is a list of items which may be helpful and are compatible with the NC-2400.

DSI

PART NUMBER	DESCRIPTION
8783	Case of tape (28 rolls/case). Roll paper tape, 1 in. wide x 1000 ft. long, .004 in. thick, 8 in. diameter with 2 in. I.D. case, uncoiled gray.
8978	EIA Cable. 6 Ft. (1.8 m) long. DB25S connector one end, DB25P other end and one to one wiring.
4052	RS-232 Cable, 10 ft. (3.0 m) long for connection to Fanuc or General Numeric 3 and 6B CNCs. Male (DB-25P) to Female (DB-25S) cable with specially designed wiring.
6241	Fuse, 3A, 250V
4277	Self-test plug, modem port
4278	Self-test plug, terminal port
8771	Tape spacing kit
7734	Cleaner, die block
4343	Starter Kit. Kit contains a) 7 rolls of paper tape, uncoiled, gray, 1 inch wide, b) die block cleaner and c) Feedhole Spacing Kit

For Field Installation:

4267	Kit, Line buffer (Option B)
4268	Kit, In memory editor (Option E)
4269	Kit, 4070 parallel and current loop input (Option H)
4270	Kit, Current loop input (Option T)

2. INSTALLATION

2.1 UNPACKING

When removing the unit from its shipping container, observe all instructions and cautions which might appear on the outside of the carton. Also, be careful not to lift or handle the cabinet by fragile parts which could be damaged.

The units have been carefully tested, inspected, and packed to insure arrival in good condition. Each is enclosed in a protective, dust-proof plastic bag, and surrounded by shock absorbing expanded urethane foam. All packing material, including the carton itself, should be saved, in the event the unit must be returned or forwarded.

Inspect the unit immediately after removal from the packing container to determine if any damage has occurred in transit. Special attention should be given to the tape reader and the plastic dust cover. If any damage is evident, report it immediately to the transporting company.

The following items should be in the carton:

- NC-2400 reader/punch unit
- Plastic dust cover for tape supply
- AC power cord set (US and Canada)
- This Installation and Operation Manual
- Core for Tape Supply

If any of these are missing, contact your dealer.

2.2 STORING AND SHIPPING

If the unit is not to be put into operation until some future time, re-package it using the original packing materials. The NC-2400 may be stored under any of the following conditions:

- Temperature: -40 to 66 degrees C (-40 to 151 degrees F)
- Relative Humidity: 5% to 95% Non-condensing

Should it become necessary to ship the NC-2400, carefully pack the equipment in a suitable container to avoid damage during transit. Whenever possible, the original shipping container from the factory should be used. If other containers are utilized, a procedure similar to the original factory packaging should be followed. (See Section 2.1 for container description.)

CAUTION: DO NOT package the equipment in a rigid container without utilizing shockmounts or shock absorbent packing material. A rigid container will allow shock on the outside to be transmitted undamped to the unit which may cause damage.

2.2 STORING AND SHIPPING, cont.

Empty the chad bin before the unit is packed for shipment. Also empty the chad chute and close its opening with masking tape (or equivalent). This will prevent chad from spreading throughout the equipment during shipment.

2.3 SITE REQUIREMENTS

The standard NC-2400 (without Option X) should be installed in an area that is free of excessive dust, dirt, corrosive fumes, and vapors. Filters are installed on units with the ruggedizing Option X. So the NC-2400X may be installed in a typical machine shop environment with oil mist, casting dust, and metal chips in the air.

To insure that the unit has proper ventilation and cooling, the ventilation openings on the bottom and the left side of the cabinet should not be obstructed. It is NOT recommended that any padding or cushioning material be placed under the unit, as this could restrict the air flow. The unit may be installed on any solid, level surface of sufficient size to accommodate the physical dimensions of the unit. The area or enclosure in which the NC-2400 will operate has to meet the following environmental conditions:

Temperatures: 5 to 40 degrees C (41 to 104 degrees F)
Relative Humidity: 5% to 95% Non-condensing

2.4 MODEL IDENTIFICATION

The model number is listed on the serial number plate which is attached to the rear side of the unit. Suffix letters to the "NC-2400" denote the options.

An NC-2400BX for example, is a reader/punch with the line buffer option (B) and the ruggedized option (X) installed. See Section 1.1 for an overview of the available options.

2.5 POWER INTERFACE

CAUTION: Prior to making any power line connections, make sure the AC power matches the voltage and frequency requirements of your NC-2400.

Although the NC-2400 has a universal power interface, we attempt to set the voltage to the requirements of your country. However, always check. If you need to change, slide the switch on the underside of the unit to the appropriate position.

A 6 foot (1.8 m) I.E.C. power cord with a 3 prong U.S. style connector is shipped with all U.S. and Canadian units. Other country requirements can be met by locally obtaining a cord.

2.5 POWER INTERFACE, cont.

115V, 50/60HZ
(NC-2400)

100V, 50/60HZ
(NC-2400J)

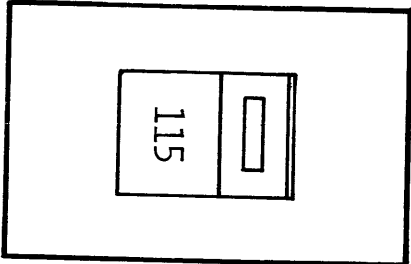

230V, 50/60HZ
(NC-2400)

200V, 50/60HZ
(NC-2400J)

FIGURE 2-1

2.6 SIGNAL INTERFACE

CAUTION: Make sure the interface of the NC-2400 matches the interface of the modem and terminal. This is especially important if the unit has the current loop option (T or H) installed. These options may be set for active or passive, 20ma or 60ma.

The different Interface/Pinouts are described in Appendices D through J.

Appendix D - RS-232 Terminal (standard)	-	DB-25S Connector
Appendix E - RS-232 Modem (standard)	-	DB-25P Connector
Appendix F - Current Loop (Option T or H)	-	6 position terminal block
Appendix G - 4070 parallel input (Option H)	-	DB-25S Connector
Appendix H - RS-232 Printer (Option E)	-	DB-25S Connector
Appendix J - Parallel Printer (Option E)	-	DB-25P Connector
Appendix K - RS-491, NC unit to punch		

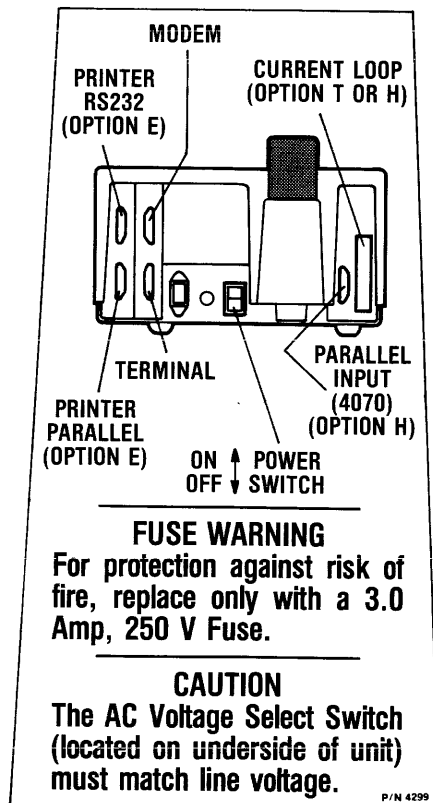

Label on Rear of NC-2400. Illustrating location of interface connectors.

Figure 2-2

2.7 CARRIAGE RETURN DELAY

This section is only applicable if the NC-2400 is connected to a printer without data buffer and which needs more than one character cycle for carriage return. Disregard this section if the utilized printer has a data buffer (DECWRITER or MODEL 43 TELETYPE, for example).

Normally, printers without data buffers require fill characters located after carriage return in the punched tape. While these fill characters are read, the printer has time to go through its carriage return cycle. The NC-2400 can be set to have an automatic carriage return delay feature. When the reader detects a carriage return character, the reading of the following character is delayed by 100ms. This feature eliminates the need for fill characters.

Since most present day printers don't require a Carriage Return delay, the NC-2400 is factory set without this delay. See Section 2.9 - Under Cover DIP Switch Settings, Figure 2-6 S201 position 2, if your printer requires the Carriage Return Delay.

2.8 DESCRIPTION OF OPTIONS

This section is only applicable to you if options are a part of your NC-2400. NC-2400X, NC-2400BX, NC-2400H, for example. It will give you a brief description of the operational features of the options.

2.8.1 OPTION P - PUNCH ONLY

This is a punch only unit. The reader has been omitted. The NC-2400P has no reader, no tape bin in front, a different cover without the reader opening and a simplified control panel.

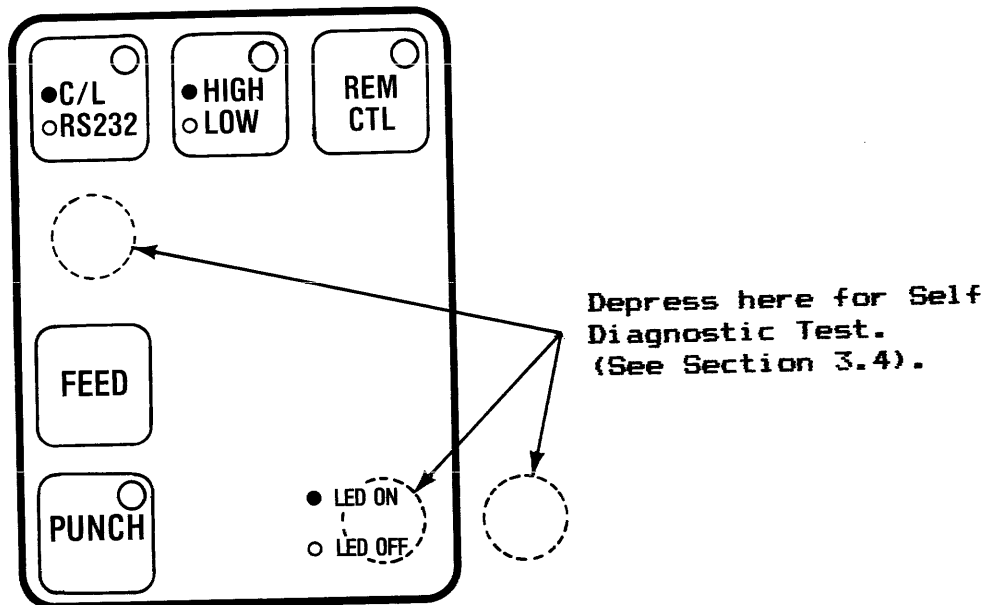

Control Panel for Option P (Punch Only)

Figure 2-3

2.8.2 OPTION X - RUGGEDIZED

This option adds air filters and a carrying handle to the NC-2400. Washable polyurethane filter sheets are on the bottom of the unit covering the air intake openings and on the side of the unit covering fan exhaust openings. A handle on top of the unit has been installed for portability of the NC-2400.

2.8.3 OPTION H - 4070 PARALLEL AND TTY CURRENT LOOP

A FACIT 4070 compatible parallel interface port, as well as a TTY Current Loop interface (for modem), is added by installing an optional circuit card (Option H), which is easily done; all the connectors and mounting holes are provided in each standard NC-2400. The 4070 interface port is intended to receive 8 bit parallel data from an external source, such as an CNC machine. The parallel interface is enabled or disabled by the PUNCH ON/OFF switch. PUNCH ON enables (PR ready), and PUNCH OFF disables (PR busy) the interface handshake. Only when OPTION H is installed along with OPTION B is a special operational procedure required to prevent operator confusion. ONLY use the OPTION H 4070 PARALLEL interface to receive data when the NC-2400 is in the LINE mode (see Section 3.3); i.e., the NC-2400 LINE/LOCAL switch is in the LINE position.

The HIGH/LOW switch on the control panel will control the punch rate. HIGH - approximately 75 characters/sec., LOW - approximately 30 characters/sec.

The parallel and current loop interfaces/pin-outs are described in Appendix G and F, respectively. The current loop interface is DIP switch settable to either ACTIVE or PASSIVE, and to 20ma or 60ma current.

STANDARD FACTORY SETTING IS 20MA PASSIVE.

The DIP switches are located on the Option H circuit card and can be set as illustrated on the label in Figure 2.4. This label is located inside the NC-2400 Cover when Option H is present.

The circuit card also has provisions for the installation of current loop controlled Reader Enable (CTS). This circuitry is not part of Option H, but components can be supplied if this feature is required. Contact Data Specialties.

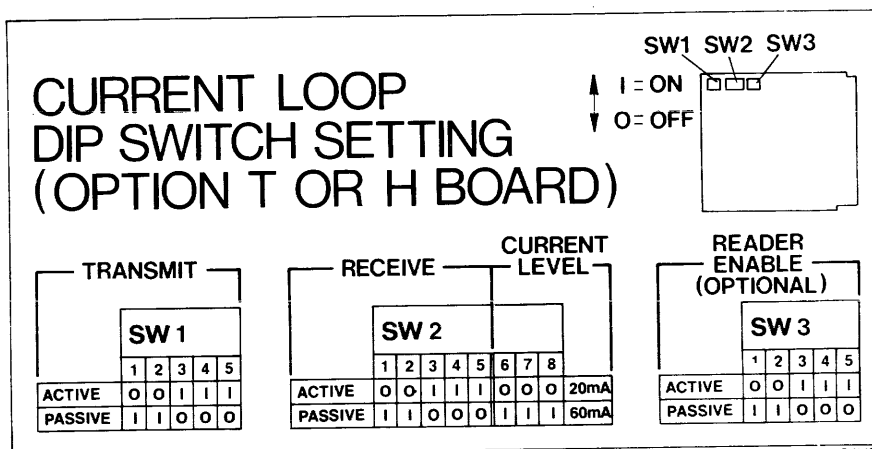

DIP Switch Setting Label on inside of Cover on NC-2400s with Option H or T.

Figure 2-4

2.8.4 OPTION T - TTY CURRENT LOOP

This option provides a current loop capability interface. It is added exactly like Option H (see previous section 2.8.3). Option T uses the same basic circuit card as Option H but less the parallel interface components.

2.8.5 OPTION B - ONE LINE BUFFER

This option provides an 80 character buffer for input data on the terminal port of the NC-2400. Data can be stored, reviewed, and edited before a command to punch the data is given. The buffer is only operational in the "local" mode, and data can be edited with simple operator commands.

Option B is typically used when the NC-2400 is part of DSI's "SYSTEM I" tape preparation system. While detailed editing information is given in the System I User's Manual, below is a summary of the editing commands/features.

The buffer is 80 bytes (characters) long. When the buffer is full, it will send a (CTRL G) BELL character back to the terminal, and will not receive any more data. Any characters coming in will be discarded.

NOTE: When OPTION B and OPTION H are installed in same unit refer to OPTION H section 2.83 for operational procedures.

CARRIAGE RETURN (CR) or a LINE FEED (LF) terminates the buffer and starts punching the data in the buffer. The last character punched will be the CR or LF.

CONTROL A will also terminate the buffer, but the Control A will not be punched.

CONTROL X will kill or remove all the data stored in the buffer. Upon receiving a CONTROL X, the NC-2400 will clear the buffer and send out to the terminal/printer the message BLOCK DELETED.

CONTROL P will send back to the terminal printer the data in the buffer. This allows the operator to review the data before he punches it.

DELETE or RUBOUT will be used to remove characters from the buffer. The DELETE or RUBOUT will send characters Backspace, Slash, Backspace to the terminal for each character removed from the buffer.

When a new character is sent to the LINE BUFFER after the delete, a LF character will be sent to the terminal and then the new character sent to the terminal.

2.8.5 OPTION B - ONE LINE BUFFER, cont.

CONTROL D will put a delete character in the LINE BUFFER and a space character will be sent to the terminal.

UNDEFINED CONTROL CODES, other than the control codes described above, will have a space character sent to the terminal, but the control code will be stored in the LINE BUFFER.

DIP SWITCH SETTINGS, basic settings in S201 position 5 and 7 and S200 position 6 will need to be as follows for proper OPTION B operation.

S200 position 6 LINE BUFFER OPTION to YES = OFF position.

S201 position 7 TERMINAL to SMART = OFF position.

S201 position 5 TERMINAL will need to be set to either CRT or Printer depending on the type of terminal to be used.

1800 CHARACTER BUFFER, with Option "B" you receive an additional buffer space for either the modem or terminal so long as the 2K RAM (memory) chip is installed at location U22 and switch S200 position 6 is in the on position. When these conditions are true and when 62% (1440 characters) is reached, an XOFF (DC-3) control code will be transmitted from the NC-2400. If the data continues to be received and the 94% point (1710 characters) is reached, the DTR signal will be turned off. After incoming data has stopped and the punch buffer has been emptied to 85% (1530 characters), the DTR signal will be turned on. When the buffer is further emptied to 20% (360 characters), an XON (DC-1) control code will be transmitted and the incoming data can resume.

If the 2K RAM (memory) chip is installed at location U22 and switch S200 position 6 is in the off position, the previous switch points hold true for the modem port and the following is true of the terminal port. The size of the buffer is 80 characters.

2.8.6 OPTION E - IN MEMORY EDITING

This option adds tremendous In-Memory Editing capability to the basic NC-2400. It is used for DSI's "SYSTEM II" Tape Preparation System; the NC-2400EHX, a CRT and a high-speed printer.

SYSTEM II is a very powerful system with nearly 400 feet of tape in-memory editing capability. Each standard NC-2400 can be field upgraded to SYSTEM II.

Detailed operational instructions are contained in the SYSTEM II Users Manual, but here are some of the highlights.

- Insertion and deletion of characters, blocks or whole sections of NC data; global search and replace.
- Store repetitive pieces of software such as canned cycles and macros in memory. Recall and insert these files with one command to make the final tool tape.
- Mass Substitutions: With a single command, change every occurrence of the specified characters.
- Resequencing: The NC-2400 allows automatic resequencing of block numbers. State the starting block character, increment and length of the block number, and the NC-2400 will do the rest.
- Arithmetic Calculations: Perform mathematic tasks such as adding, subtracting, multiplying, and dividing without computer assistance.
- Line Number Display: Reference line numbers as well as block numbers can be displayed when listing a file, making editing easier.
- Manreadables: Enter useful information such as a part number, drawing number, and time of day, and it will appear on the tape leader.
- Convert ASCII to EIA or vice versa whenever you like, with or without printing or punching.
- Automatic Offset: Add or subtract any value from any dimension, with or without leading or trailing zeroes.
- Programmable Format: Automatically puts all the NC terms in the proper order with the selected number of characters and the proper decimal location.
- Selectable Leader and Trailer: From the keyboard, select the amount of nulls, deletes, and spaces required for the leader and trailer of the tape, and the NC-2400 System will put them on automatically.

- Verification: A number is calculated and displayed on the CRT. This helps to insure accurate tape reading and punching.

The NC-2400E has a simplified control panel as illustrated in Figure 2.5. REM CTL, FULL/HALF, and LINE/LOCAL are not switches but act as indicators only.

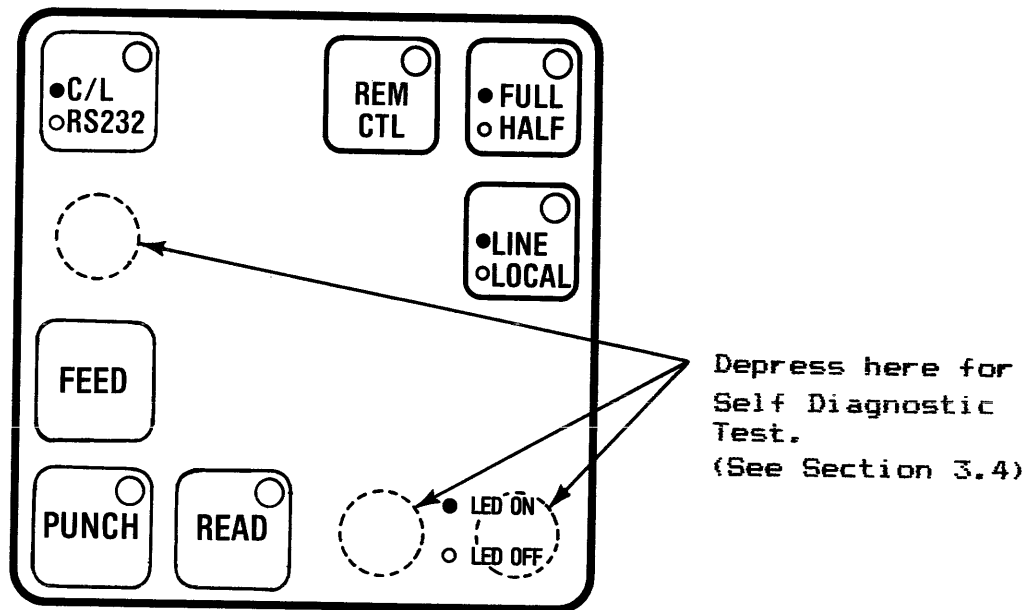

Control Panel for Option E (In Memory Editor) Figure 2-5.

2.8.7 OPTION J - 100/200VAC

The power interface on Option J units is 100/200VAC, 50 or 60Hz, in lieu of the standard 115/230VAC, 50 or 60 Hz. The standard factory setting of this option is 100 Volts.

2.8.8 OPTION M - 5 LEVEL

NOT AVAILABLE AT TIME OF PUBLICATION.

2.9 UNDER COVER DIP SWITCH SETTINGS

The NC-2400 has 5 sets of DIP switches underneath its cover. The switches are located on the main circuit board as shown in Figure 2.6. This figure illustrates the DIP Switch Setting label located on the inside surface of the NC-2400 cover.

These switches are used to enable or disable certain features of the NC-2400; i.e., to make its electronics flexible to meet your requirements. They are used to set Baud rates, 5 or 8 level, CR delay, default states (see next Section 2.9.1), presence of options, etc.

The standard settings of the switches on a basic NC-2400 are circled in Figure 2-6.

**NOTE: TO ENTER NEW SWITCH SETTINGS TURN NC-2400 POWER OFF,
CHANGE SETTINGS AND TURN ON POWER.**

2.9.1. DEFAULT STATES

Switch 202 is used to set the DEFAULT/Power Up conditions of the control panel switches.

For example, when you power up a factory set NC-2400, the control panel comes up with High Baud, Full Duplex, Line, Punch On, Remote Control Off, Terminal Off. If other switch (default) states are more convenient for your applications, change the DIP switch settings as required.

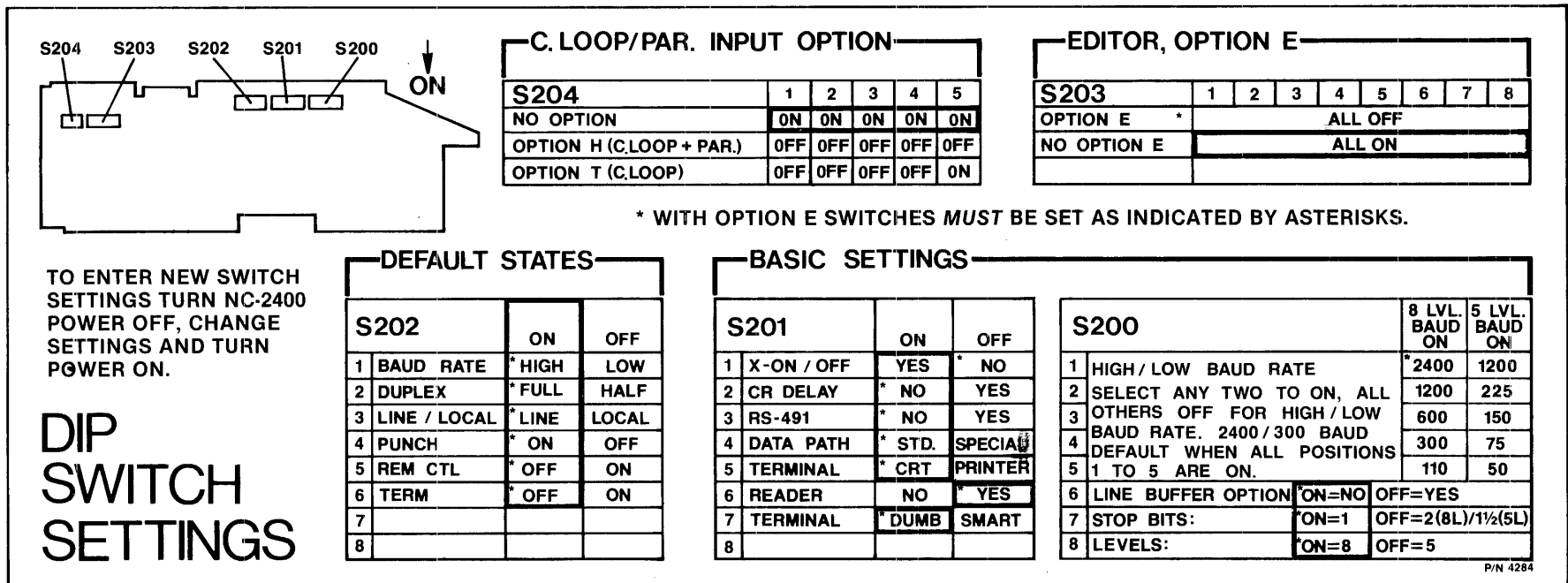

Figure 2-6



= Standard (Factory) DIP Switch Settings

P/N 4284

2.9.2 BASIC SETTINGS

Switches 201 and 200 are used to set up the basic configuration of the NC-2400, reference Figure 2-6.

Switch 200 is used to set up the type of communication such as baud rate, stop bits and 5 or 8 levels. The first five positions, 1 through 5, are used to set the Baud Rates. Baud rates are set as a pair, that is there is a high baud and a low baud. The possible combination of pairs are shown in Figure 2-6. When all these baud switches are in the ON position, this is the standard factory default of 2400 high baud, 300 low baud.

Switch 200, position 6 "LINE BUFFER Option", is used to enable OPTION B when it is installed into an NC-2400. For more information on OPTION B refer to Section 2.8.5.

Switch 200, position 7 "STOP BITS", is used for the RS-232 communication. When the "LEVELS" switch is set for 8 level, the NC-2400 can transmit 1 or 2 stop bits. When the "LEVELS" switch is set for 5 Level, the NC-2400 can transmit 1 or 1 1/2 stop bits.

Switch 200, position 8 "LEVELS" is used for the RS-232 communications. When set to 8 Level, the NC-2400 will receive and transmit 8 data level code; when set to 5 Level, the NC-2400 will only receive and transmit 5 data level code.

Switch 201 is used to set up some of the special operational features of the NC-2400. Some of these features are covered in Sections 2.8.5, 2.8.1, 2.7 and Appendix K.

Switch 201, position 1 "XON-XOFF", when in the ON position, the NC-2400 will transmit the XON(DC-1) XOFF(DC-3) control codes as certain input punch buffer watermark points are reached. The size of the punch buffer is 160 characters in length, when 63% (100 characters) is reached an XOFF(DC-3) control code will be transmitted from the NC-2400. After incoming data has stopped and the punch buffer has been emptied to 25% (360 characters), an XON (DC-1) control code will be transmitted and the incoming data can resume.

If Option "B" is installed the buffer points will reflect new switch points (watermark). The size of the punch buffer is then 1800 characters in length, when 62% (1440 characters) is reached, an XOFF (DC-3) control code will be transmitted from the NC-2400. After incoming data has stopped and the punch buffer has been emptied to 20% (360 characters), an XON (DC-1) control code will be transmitted and the incoming data can resume.

Switch 201, position 2 "CR DELAY", reference Section 2.7 CARRIAGE RETURN DELAY.

Switch 201, position 3 "RS 491", reference APPENDIX K INTERFACE; RS491.

Switch 201, position 4 "DATA PATH", affects the reader data. When the "DATA PATH" is set to "STD" (standard) and the NC-2400 is in LOCAL, data from the tape in the reader will go to the punch and be punched. When the "DATA PATH" is set to "SPECIAL" and the NC-2400 is in LOCAL, data from the tape in the reader will not go to the punch. In this mode to punch a tape from the reader, the NC-2400 must be in HALF DUPLEX.

Switch 201, position 5 "TERMINAL", is used in conjunction with OPTION B, reference Section 2.8.5. When the "TERMINAL" switch is set for "CRT", a CRT must be used as the terminal device and when set for "PRINTER", a printer must be used as the terminal device.

Switch 201, position 6 "READER" is used to enable or disable the reader. Reference Section 2.8.1 OPTION F punch only.

Switch 201, position 7 "TERMINAL" is used in conjunction with OPTION B, reference Section 2.8.5. When "TERMINAL" dip switch is set for "DUMB", all data incoming from the terminal into the NC-2400 will be echoed back to the sending terminal. When in the "SMART" position, data will be echoed back only when in HALF DUPLEX.

2.9.3 OPTION SETTINGS

Switch 203 and 204 are used to connect optional features of the NC-2400 System, reference Figure 2-6.

Switch 203 all positions are used to switch in the OPTION E editor, reference Section 2.8.6. Unless OPTION E is installed in the NC-2400 System, Switch 203 all positions must be in the ON position.

Switch 204 positions are used to switch in the options Current Loop and Parallel In or optional Current Loop, reference Sections 2.8.3 and 2.8.4. Unless these options are installed, Switch 204 all positions must be in the ON position.

3. OPERATING GUIDE

3.1 TAPE LOADING

The unit will accommodate tape rolls with a two-inch core diameter and up to eight inches outside diameter. See Appendix A for recommended tape materials.

Refer to Figure 3-1 and label on unit when following this procedure:

- a. Check the roll of tape to be certain that it is flat and not distorted or "coned" in the center. If this distortion does exist, lay the roll on a flat surface and push downward to force the distorted areas back into place. Do not break the seal on the roll at this time.
- b. Put the plastic core into the roll.
- c. Position tape roll with plastic core in cradle of NC-2400 cover as illustrated in Figure 3-1.

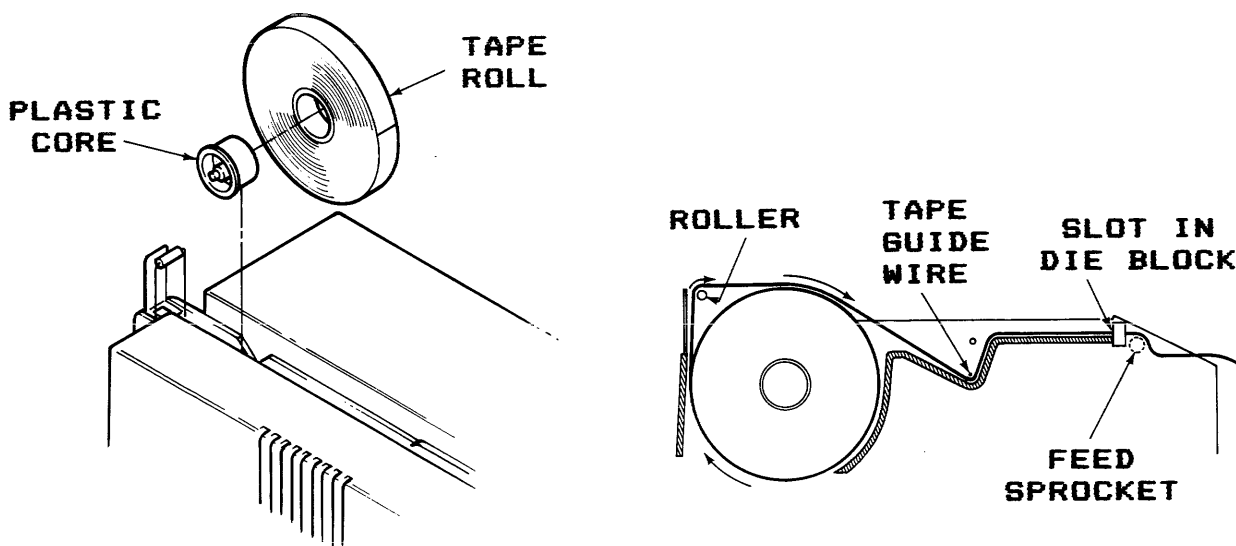

Tape Loading

Figure 3-1

3.1 TAPE LOADING, cont.

- d. Break the seal on the tape roll, tearing (or cutting) off the first layer of tape and making sure the segment of tape that was glued is removed. This will prevent undue difficulty in threading the tape through the punch block. When tearing off the leading edge of the tape, attempt to make the tear as even as possible; use scissors to assure a clean cut. With MYLAR tape, scissors **MUST** be used.
- e. Route the tape around the roller, under the tape guide wire, and through the slot in the die block as illustrated. The TOP and  on printed tape (when used) will show now on top.
- f. Now, with the POWER switch in the ON position, with one hand push the tape further forward, until the leading edge butts up against the feed sprocket; at the same time depress the FEED switch with the other hand. As you continue to push the tape forward, the feed sprocket will become engaged with the tape and pull it through the machine. Continue to depress the FEED switch until approximately 1 foot (30 cm) of tape hangs from the front of the unit. The unit is now ready for operation.

3.2 TEARING OFF TAPE

To tear off (or cut off) punched tape, it may be desirable to push the FEED control button to allow some additional tape at the end of the punched message. Holding the tape firm, pull the tape quickly upward and slightly toward the back of the machine. The cutting blade will then sever the tape easily. The cutting blade will work most efficiently when used in this manner.

DO NOT attempt to tear off the tape by pulling it to one side or the other.

3.3 CONTROLS AND INDICATORS

Figure 3.2 illustrates the controls and indicators of the standard NC-2400, except the power switch which is located on the rear side of the unit. Sealed membrane type switches are used and the legend plate can easily be changed when different Options are installed, i.e., Option P and Option E require a different control panel layout/legend plate. See Section 2.8.1 and 2.8.6 respectively.

3.3 CONTROLS AND INDICATORS, cont.

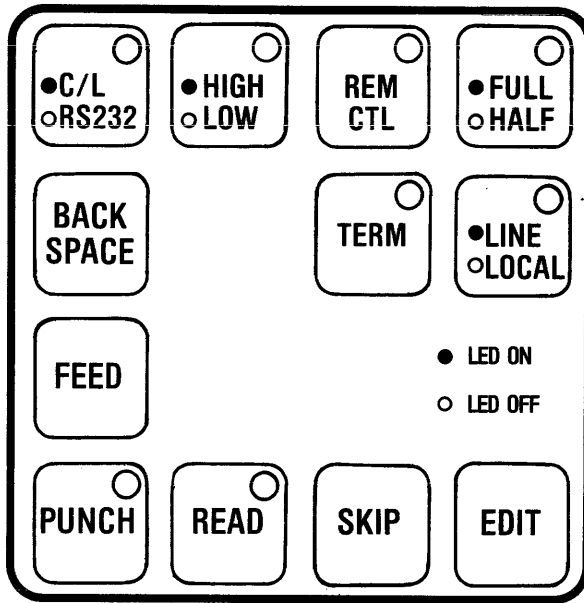

Controls and Indicators
of Standard NC-2400

Figure 3-2

POWER ON/OFF switch. This switch (which is on the back of the unit) controls the AC power to the NC-2400. When the unit is first powered up the various controls and LED indicators came up in defined states (ON or OFF, etc.). These are called Default States.

Factory Set DEFAULT STATES on power up.

Punch	ON*
Reader	OFF
Baud Rate	HIGH*
Duplex	FULL*
Line/Local	LINE*
Remote Control	OFF*
C.Loop/RS232	RS-232
Terminal	OFF*

* These default states are DIP switch selectable and factory set as stated. See Section 2.9 for instructions.

READ switch with INDICATOR. A momentary depression of this switch will cause the reader to start reading tape at the selected baud rate. The ON state is indicated by an illuminated LED. A second momentary depression will cause the reader to stop (LED OFF).

3.3 CONTROLS AND INDICATORS, Cont.

EDIT switch. This is a very powerful local tape editing control switch with three functions: first, a short momentary depression of less than 1/2 second duration will cause the reader to advance one step, i.e., read one character. Second, holding the switch depressed will cause the reader to search until a Carriage Return character is detected; the reader will then stop. To restart, the switch has to be released and depressed again. Third, the release of the switch prior to detection of a Carriage Return character will stop the reader also. Use of this switch send data to the punch and to the terminal port.

To give visual feedback of the switch actuation, the READER ON switch LED state is "toggled" whenever the READER EDIT switch is actuated. For example, depressing the READER EDIT switch momentarily while the READER switch LED is OFF, causes the LED to go OFF for the duration of the switch depression.

SKIP switch. This switch has the same three functions as the EDIT switch, except no data is transmitted from the reader. In other words, its effect is only mechanical motion of the tape through the read head, thus skipping over the characters on the tape.

It also uses the READER LED for visual feedback (LED toggling) as described in the previous section.

PUNCH switch with INDICATOR. A momentary depression of this switch will enable or disable the punch. The ON (enabled) state is indicated by a lit LED. This switch has to be ON before the punch can respond to any data input.

FEED switch. Depression of this switch results in the punch feeding out a tape with NULL characters (feedholes only) at approximately 30 cps. The feed out will stop when the switch is released. The PUNCH ON switch does not have to be on for the PUNCH FEED Switch to work.

TERM switch and INDICATOR. This switch controls transmitted and received data through the terminal port of the NC-2400. For example, when the switch is ON (LED ON), data being punched is also transmitted to a connected printer/terminal. In the OFF state, LED OFF, no data is transmitted or received through this port.

3.3 CONTROLS AND INDICATORS, cont.

LINE/LOCAL switch and INDICATOR. When this switch is in the LINE position (LED ON), data may be transmitted and received through the modem port of the NC-2400. In the LOCAL MODE, the receive/transmit lines of the modem port are disabled and only local operation can be performed.

HIGH/LOW BAUD switch and INDICATOR. The rate at which characters are transmitted and received by the reader and punch is controlled by this switch. Factory settings are: LOW - 300 baud (LED OFF), HIGH - 2400 baud (LED ON). If the Baud rates are changed in the field, the NC-2400 will automatically put the faster of the baud rates in the high position.

FULL/HALF DUPLEX Switch and INDICATOR. In Half Duplex operation, the data transmitted by the reader may simultaneously be received by the punch. In Full Duplex (LED ON), the punch and the reader may receive and transmit different data simultaneously and independently from each other.

C/L RS232 switch and INDICATOR. This switch is used to switch the modem port between RS232 and current loop. The feature allows you to have both an RS232 unit and a current loop unit connected to the NC-2400 at the same time, but use only one at a time. The RS232 state has LED OFF, current loop LED ON. When the CURRENT LOOP option is not installed, the RS232/CURRENT LOOP LED will not light when the switch is depressed.

REM CTL switch and INDICATOR. When this switch is in the ON state (LED ON), the unit may be controlled from a remote terminal operating in full duplex with the NC-2400. The reader and punch will turn on and off in response to the following control codes.

FUNCTION	ASCII CODE	
Reader Start	DC1	CTL Q
Punch Start	DC2	CTL R
Reader Stop	DC3	CTL S
Punch Stop	DC4	CTL T

BACK SPACE SWITCH. A momentary depression of this switch will cause the tape in the punch to backspace by one character. The switch has to be released and depressed again for another backspace to take place. This sequence can be repeated as many times as required.

3.4 SELF DIAGNOSTIC CHECKS

Built into the unit are self-check routines which allow you to test the NC-2400. Simultaneous depression of certain control panel switches during power-up (i.e., while the POWER switch is being turned on) will activate each test routine.

NOTE: The control panel switches to activate the self-diagnostic checks are described for the basic NC-2400 with the control panel illustrated in Figure 3-2. NC-2400s with Option E or Option P have a different control panel with fewer switches than on the basic NC-2400. To activate diagnostic routines on these units, depress the control panel in the areas where the specified switches would be located on the standard NC-2400 control panel. These areas are marked in Figure 2.5 and Figure 2.3 (Option E and Option P control panel layout).

LED INDICATOR CHECK. Simultaneous depression of SKIP and EDIT switches during POWER UP will test the LED indicator lights; they will all flash ON/OFF.

PUNCH CHECK. Three different test patterns may be punched (called up from the NC-2400 memory). Again, by depressing certain switches during POWER UP.

During Power Up Depress:

FEED
and PUNCH

BACKSPACE
and PUNCH

BACKSPACE,
FEED
and PUNCH

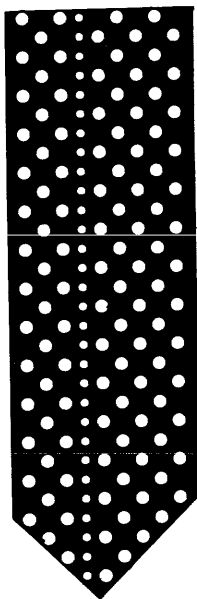

U*

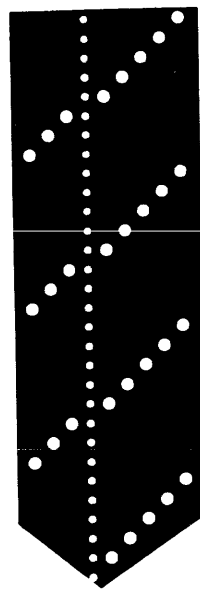

RAMP

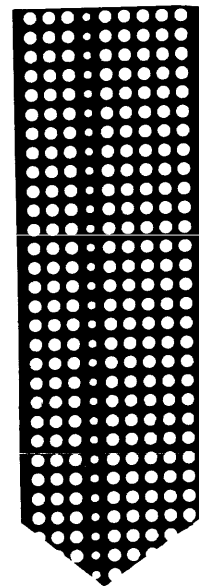

RUBOUT

Figure 3-3

3.4 SELF DIAGNOSTIC CHECKS, cont.

READER CHECK. The reader may be tested by reading a tape, having the data punched by the punch, and then visually comparing the two tapes.

To do this, load the U* tape (from PUNCH CHECK) into the reader, put the Line/Local switch into the LOCAL state, and the FULL/HALF switch in the HALF duplex state. Now turn on the reader and punch to duplicate the tape.

MODEM PORT CHECK. This is similar to the Reader Check, but the data from the reader is routed through the modem port to the outside of the NC-2400, looped back, and then fed to the punch. To perform this test, DSI P/N 4277 Self-test plug is required; see Section 1.4.

Load U* tape in reader, put NC-2400 in LINE, FULL, REM CTL OFF, TERMINAL OFF, and RS-232 mode, then turn reader and punch on to duplicate tape.

TERMINAL PORT CHECK. This is similar to the Reader Check, but the data from the reader is routed through the terminal port to the outside of the NC-2400, looped back, and then fed to the punch. To perform this test, DSI P/N 4278 Self test plug is required, see Section 1.4.

A DIP switch underneath the cover also has to be changed for this test. Set the DATA PATH switch (SW201) to SPECIAL. See Section 2.9. Now load U* tape in reader, put NC-2400 in LOCAL, FULL, TERMINAL ON, REM CTL OFF, and RS-232 mode, then turn reader and punch on to duplicate tape.

3.5 TAPE READER

The NC-2400 utilizes an optical tape reader with a sprocket drive which moves the tape from left to right. To LOAD TAPE in the reader; raise the lid to expose the read station, slide the tape between the tape guide pins (see Figure 3.4), engage the feedholes with the drive sprocket and lower the lid carefully. The tape is now ready to be read.

When making tapes, it is advisable to precede any data with enough leader tape so no character alignment is necessary when loading tape in the reader. The reader operates in the READ-FEED mode. A character is first read and then the tape is advanced until the next character is in alignment with the read station. If it is necessary to read a particular character, align the character to be read with the arrow on the read station when loading the tape.

It is advisable to use only good quality tapes. See Appendix A for recommended materials. Transparent spots, uneven density and width out of tolerance, typically associated with substandard tapes, may cause reader errors.

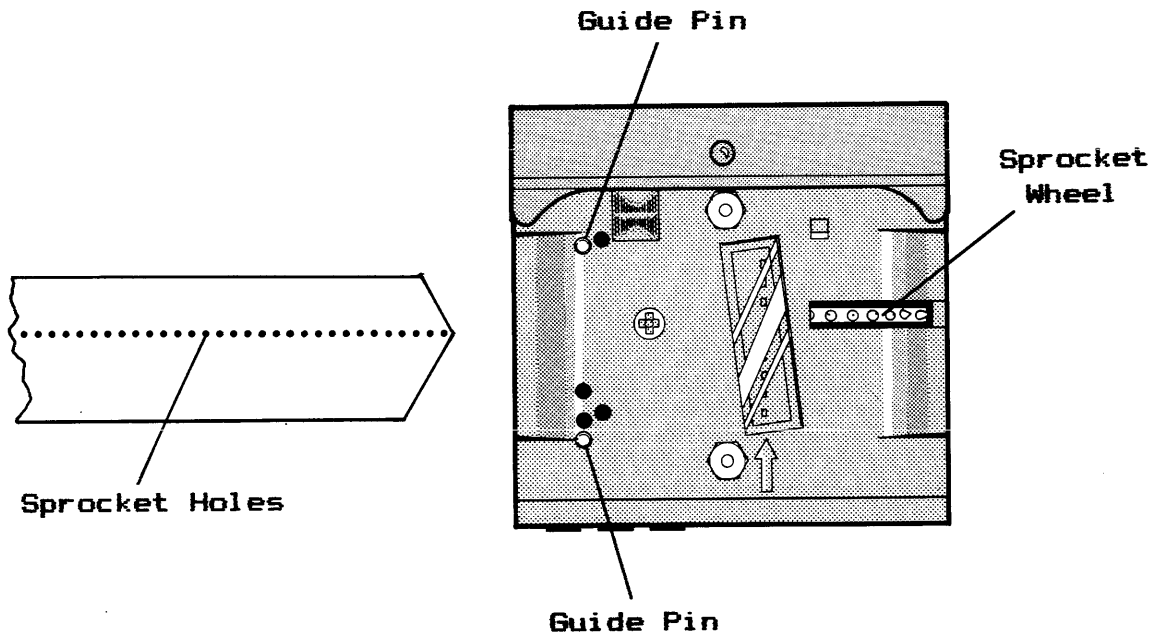

READER

Figure 3-4

3.6 TAPE ORIENTATION/BIT ASSIGNMENT

Figure 3.5 illustrates the orientation and the bit assignment of the tape in relation to punch and reader.

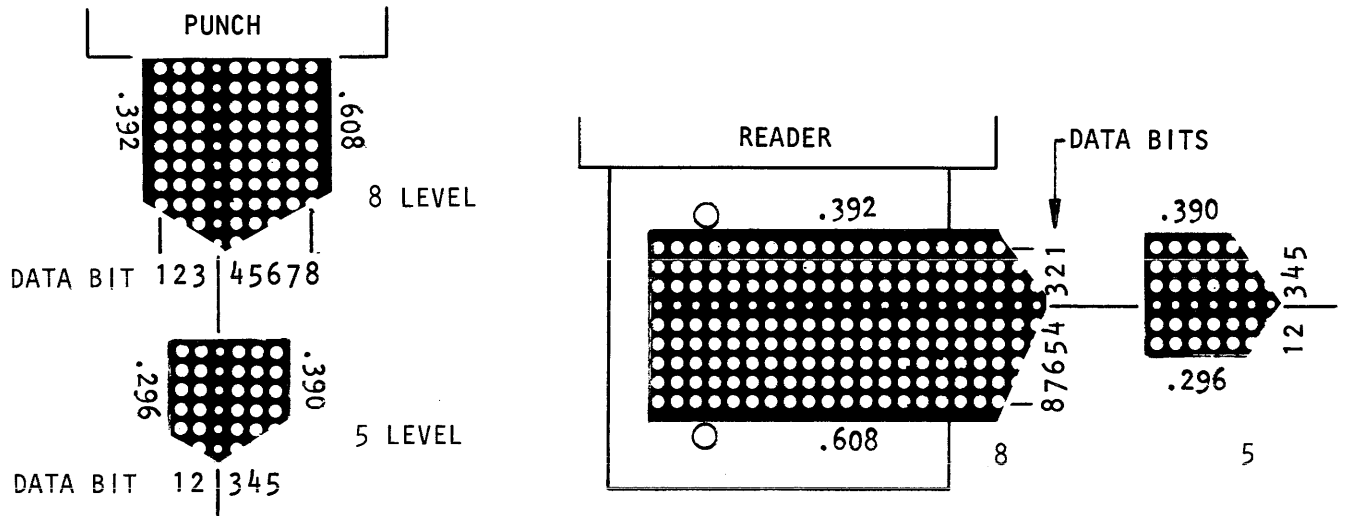

Tape Orientation/Bit Assignment

Figure 3-5

3.7 TAPE PERFORATOR

The perforator utilized in the NC-2400 is Data Specialties MODUPERF mechanism. This is an extremely long life unit. The tape is advanced not with a capstan but with a sprocket wheel. This means NO ADJUSTMENTS are necessary when switching between different kinds of tapes. The feeding accuracy is not affected by different thicknesses or surface textures of the tape. Tapes are reliably perforated by the positive push/pull action of the punch pins; i.e., no retraction springs are used. The long life, precision die blocks are interchangeable in minutes.

No take up spooling is provided for the punch or reader. Short tapes are typically taken up by hand or the tape is accumulated in a suitable container such as a box, wastebasket, etc. Avoid spilling the tape on the floor where it is prone to pick up dirt or get damaged.

3.8 TYPICAL APPLICATIONS

The following is a short outline of how a standard NC-2400 can be utilized to do some elementary editing and tape preparation. When the NC-2400 is used as part of DSI's SYSTEM I or SYSTEM II, use the respective User's Manual for detailed application information.

3.8 TYPICAL APPLICATIONS, cont.

PREPARING TAPE WITH LOCAL KEYBOARD/PRINTER:

Put the controls on the keyboard/printer in the LINE and FULL DUPLEX mode. Set the NC-2400 on LOCAL, FULL or HALF DUPLEX, BAUD rate to match keyboard/printer, PUNCH ON, and TERMINAL ON.

If a typing error occurs, the tape can be corrected in the following manner. Depress the BACKSPACE switch on the NC-2400. Each depression will cause the tape to step one character backwards. If one character has to be corrected, backspace once; if five characters have to be corrected, backspace five times. Now depress the DELETE key on the keyboard of the printer. Each depression will cause a DELETE/RUBOUT character to be punched; that is all 8 data holes will be punched and the character will be deleted. When the tape is read, the deleted characters will be ignored. Once completed, the new/proper data may now be typed.

ON LINE WITH KEYBOARD PRINTER (ASR CONFIGURATION):

Set the controls of keyboard/printer to LINE and FULL DUPLEX. Set the NC-2400 on LINE, FULL DUPLEX, BAUD rate to match keyboard printer and modem, PUNCH ON and TERMINAL ON. With the modem port of the NC-2400 connected to a modem, the equipment can now go on line in the full duplex mode, meaning different data may be received and transmitted simultaneously.

DUPLICATING TAPE:

This may be done with the NC-2400 as a stand-alone, or with a printer or terminal connected to it. Set the controls on the NC-2400 to HIGH (baud rate), TERMINAL OFF, FULL or HALF duplex, LOCAL and PUNCH ON. Depress PUNCH FEED switch to generate desired length of leader. Load reader with tape to be duplicated. Depress READER RUN switch to duplicate tape.

PRINTING FROM TAPE:

Controls of keyboard/printer are on LINE and FULL DUPLEX. The NC-2400 is set on LOCAL, HALF DUPLEX, BAUD rate to match keyboard/printer, and TERMINAL ON. Load reader with tape to be printed. Depress READER RUN switch to print data from tape.

TAPE EDITING

To edit tapes the NC-2400 is connected to a keyboard/printer or CTR terminal. Controls on this terminal are set to LINE and FULL DUPLEX. The NC-2400 is in LOCAL, FULL or HALF DUPLEX, BAUD rate to match terminal, PUNCH ON, and TERM ON. Load the reader with the tape to be edited. Use the READER RUN and/or EDIT control to read (print and duplicate) the tape. Stop the reading of the tape just before the character to be deleted. Depress the SKIP switch to skip over the character (will not be punched). Duplicate rest of tape by depressing the READER RUN switch.

3.8 TYPICAL APPLICATIONS, cont.

TAPE EDITING - ADDITION OF CHARACTER:

Set the controls as above. Load the reader with the tape to be edited. Use the READER RUN and EDIT control to read (print and duplicate) the tape until the spot where a new character should be added. Add the new character or characters via the keyboard. Duplicate the rest of the tape by depressing the READER RUN switch.

TAPE EDITING - CHANGING OF CHARACTER:

This is a combination of deletion and addition of characters as described above.

3.9 OPERATOR CARE

- GENERAL - Do not use the cover to hold pencils, papers, paper clips, etc.
- Use only a lint-free cloth to clean the NC-2400. Do not use solvents or harsh cleaning agents. If excessively dirty, a mild detergent solution or desktop cleaner may be used sparingly.
- PUNCH - As required, clean die block area with a soft bristle brush.
- READER - As required, remove any dirt/lint accumulations in the read station area and the LEDs (underside of lid) with soft bristle brush.
- OPTION X - As required, clean (wash) the filter pad on bottom of unit so the air flow is not restricted by a clogged up (dirty) filter.

APPENDIX A

RECOMMENDED TAPE MATERIALS

PAPER TAPE. Unoiled colored or buff tape with a maximum 55% transmissivity is recommended. Black tape should be avoided since sometimes carbon dye or unusually high grit contents are used which is very detrimental to the wear characteristics of the punch pins. The tape should be from a quality manufacturer and meet EIA Standard RS-227-A.

CAUTION: Oiled buff tape is not recommended. The 5 to 12% oil in these tapes sometimes causes highly transparent spots to occur. These spots, combined with the light yellow "buff" color, may exceed 55% light transmissivity and cause reader errors. While oiled tapes of grey and darker colors are acceptable since their transmissivity is well below 55%, the oil in the tape is of no value since it has an insignificant effect on the life expectancy of the MODUPERF punch head.

MYLAR TAPE. Metalized Mylar, Mylar/Foil/Mylar, or Paper/Mylar/Paper tapes may be used. They may range in thickness from .0025 in. to .0040 in. There again, it is recommended that the tape should be from a quality manufacturer.

MINIMUM LIFE EXPECTANCY OF PUNCH HEAD:

Paper Tape; any color but black	2,000,000 feet of tape (240 million char.)
Paper Tape; black color	500,000 feet of tape (60 million char.)
Mylar Tape;	500,000 feet of tape (60 million char.)

Both PAPER and MYLAR tapes, if of poor quality, will cause problems in punching and/or reading. For example, the tape might have the following defects: transparent spots, width out of tolerance, splices in roll or roll not continuous, torn folds (fanfolds), tape delamination (mylars), etc. Data Specialties has tested the tapes of the suppliers listed below and found them to be acceptable. This list is not meant to be exclusive.

P,M ARVEY CORP.
3500 N. Kimball Ave.
Chicago, IL 60618
(312) 463-1400

P OCCIDENTAL
1188 Montague View
San Leandro, CA 94577
(415) 352-3202

P,M CHASE FOSTER
199 Amaral St.
East Providence, RI 02914
(401) 434-2340

P PAPER MANUFACTURES CO.
9800 Bustleton Ave.
Philadelphia, PA. 19115
215) 673-4500

P EASTERN SPECIALTIES
P.O. Box 350
Holyoke, MA 01040
(413) 533-7103

P RIBCO
200 Railroad Ave.
Paterson, NJ 07509
(201) 271-4848

P - PAPER TAPES
M - MYLAR TAPES

APPENDIX B

TAPE SPACING STANDARDS/ADJUSTMENTS

The intent of this section is to clarify tape spacing specifications, tape spacing measurements, and (if required) how to adjust tape spacing to meet the requirement of a particular non-DSI reader.

Each DSI system produces tapes which meet the following US and international standards:

EIA RS-227-A
ISO 1154 8 Level Tape
ANSI X3.18
ANSI X3.19 (5 Level Tape)

All of these specifications are the same in regards to tape spacing. They state:

"Longitudinal error between centers of feed holes may accumulate up to plus or minus .025 inch, within any span of 50 spaces (5.0 inches)." This is commonly called the 5 INCH SPACING.

While these specifications were written in the age of the mechanical tape readers, they still serve as a valuable guide to present day punch manufacturers. Today's optical readers can accurately read tape with much greater variations than is specified above.

To MEASURE the 5 inch spacing, perforate a length of tape with a typical code arrangement. Then use DSI's Tape Spacing Kit, P/N 8771, or any accurate scale with .1 inch gradations and follow the instructions on Figure B-1.

To ADJUST the 5 inch spacing, remove the cover of the unit to gain access to the stepper motor which drives the tape sprocket wheel. This stepper motor is located just below the tear edge of the tape exit on the punch. Then follow instructions in Figure B-1.

check

TYPE 1

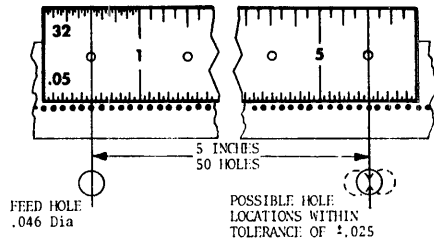

Center a feed hole on a .100 inch graduation at one end of the gauge. See figure. Feed holes must be centered in line with the graduations for a minimum of 5 inches and meet spacing requirements.

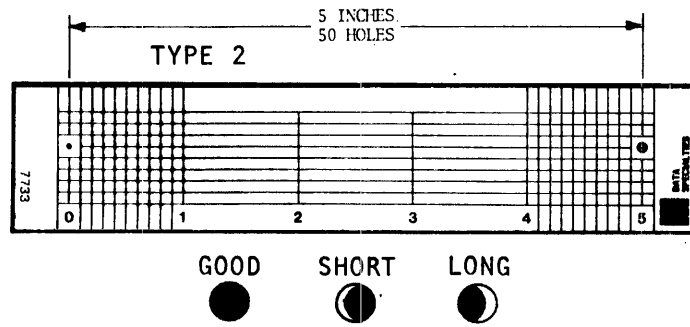

Center a feed hole directly over the small black dot on the left side of the gauge. The feed holes must be centered in line with the graduations for a minimum of 5 inches. When the 50th feed hole is positioned over the larger black dot only black should be seen. If any silver shows, the hole spacing is out of tolerance. See figure.

adjust

STEPPER MOTOR

You will see one of these two types on your unit.

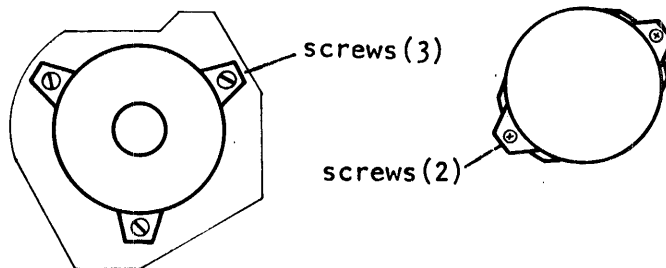

Loosen stepper motor mounting screws just enough so stepper motor can be rotated manually. Rotate clockwise for longer spacing. Rotate counterclockwise for shorter spacing. Tighten screws and re-check spacing.

CAUTION: Stepper Motor may be HOT

APPENDIX C

ASCII CODE CHART AND TAPE SAMPLE

The sample tape is shown with leader (null) preceding and following the data. The point of the tape indicates direction of tape motion. Bit No. 8, while not defined by the ASCII Code, is used for even or odd parity or other checking schemes. The sample illustrates even parity. (See Figure C-1).

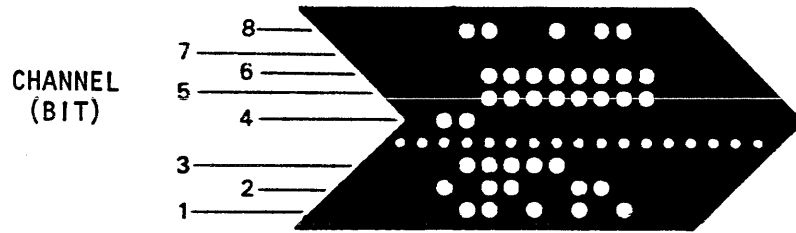

American National Standard
Code for Information Interchange

Bits					COLUMN								
					0 0 0	0 0 1	0 1 0	0 1 1	1 0 0	1 0 1	1 1 0	1 1 1	
b ₇	b ₆	b ₅	b ₄	b ₃	ROW	0	1	2	3	4	5	6	7
0	0	0	0	0	0	NUL	DL	SP	0	@	P	\	p
0	0	0	1	1	1	SOH	DC1	!	1	A	Q	a	q
0	0	1	0	2	2	STX	DC2	"	2	B	R	b	r
0	0	1	1	3	3	ETX	DC3	#	3	C	S	c	s
0	1	0	0	4	4	EOT	DC4	\$	4	D	T	d	t
0	1	0	1	5	5	ENQ	NAK	%	5	E	U	e	u
0	1	1	0	6	6	ACK	SYN	&	6	F	V	f	v
0	1	1	1	7	7	BEL	ETB	/	7	G	W	g	w
1	0	0	0	8	8	BS	CAN	(8	H	X	h	x
1	0	0	1	9	9	HT	EM)	9	I	Y	i	y
1	0	1	0	10	10	LF	SUB	*	:	J	Z	j	z
1	0	1	1	11	11	VT	ESC	+	;	K	[k	{
1	1	0	0	12	12	FF	FS	,	<	L	\	l	
1	1	0	1	13	13	CR	GS	-	=	M]	m	}
1	1	1	0	14	14	SO	RS	.	>	N	^	n	~
1	1	1	1	15	15	SI	US	/	?	O	_	o	DEL

ASCII Code Chart and Tape Sample

Figure C-1

APPENDIX D

TERMINAL RS-232C INTERFACE STANDARD, DB25S CONNECTOR (P4)

- Pin 2 Data From Terminal. This input lead is the Serial data input to the unit from the terminal. Data on this lead will be fed to the punch, character detection logic, or sent on-line as selected by the controls.
- Pin 3 Data To Terminal. This output lead is the Serial data output to the terminal. When the terminal is deselected, this lead will be held in the "OFF" state.
- Pin 4 Request To Send. This input lead when in LOCAL mode can be used to control the reader. When driven to the "OFF" state the reader will be inhibited from sending. When it is left unwired or in the "ON" state, the reader will be enabled.
- Pin 5 Clear To Send. This out is always in the "ON" condition when the terminal port is activated.
- Pin 6 Data Set Ready. This output lead when in the LOCAL mode can be used to indicate the status of the internal buffer. When the buffer reaches the 94% full mark (150 characters) DSR will be placed in the "OFF" state. It will go back to the "ON" state when the buffer reaches 66% (105 characters). The lead will be in the "ON" state even in the LINE mode.
- Pin 7 DC Ground. This lead serves as the voltage reference between the interfaced devices.
- Pin 8 Carrier Detect. This output is always in the ON condition.
- Pin 20 Data Terminal Ready. This input lead is used by the NC-2400 to determine if the Terminal is on.
- Pins 1, 6, 9-19, 21-25 Unterminated.

APPENDIX E

MODEM RS-232C INTERFACE STANDARD DB25P CONNECTOR (J3)

-Pin 2 Transmitted Data. This is the serial data output of the unit. When the NC-2400 is in the LOCAL mode, this lead is held in the "OFF" state.

-Pin 3 Received Data. This lead is the serial data input to the NC-2400 from the modem. When the NC-2400 is in the LOCAL mode, this input is ignored.

-Pin 4 Request To Send. This lead is an output of the NC-2400. It is in the "ON" state when the unit is in the LINE mode and the reader switch is "ON". RTS is in the "OFF" state when the unit is in the LOCAL mode and/or the reader is "OFF".

-Pin 5 Clear to Send. This input lead can be used to control the NC-2400 reader. When this lead is driven to the "OFF" state, the reader will be inhibited from sending. When this lead is left unwired or driven to the "ON" state, the reader will be enabled.

-Pin 6 Data Set Ready. This lead is an input to the NC-2400, but is inoperative at this time.

-Pin 7 DC Ground. This lead serves as the voltage reference between the interfaced devices.

-Pin 8 Carrier Detect. This lead is an input to the NC-2400, but is inoperative at this time.

-Pin 20 Data Terminal Ready. This out indicates whether the NC-2400 is in the Line or Local mode. When the unit is in the Line mode, this signal will be in the "ON" state. This signal also indicates the status of the buffer. When the buffer reaches the 94% full mark (150 characters) DTR will be placed in the "OFF" state. It will go back to the ON state when the buffer reaches 66% (105 characters).

-Pins 1, 9-19, 21-25 Unterminated.

APPENDIX F

MODEM CURRENT LOOP OPTION T OR OPTION H 6-POSITION TERMINAL
BLOCK

- Pos 1. +Receive. This lead is the Current Loop serial data positive terminal for data input from the modem. Data on this lead will be fed to the terminal, punch, or as the character detection logic as selected.
- Pos 2. -Receive. This lead is the negative terminal connection for completion of the receive current loop.
- Pos 3. +Transmit. This lead is the current loop serial data positive terminal for data output to the modem. When the LOCAL mode is selected, there will be current flow (mark) to the modem.
- Pos 4. -Transmit. This lead is the negative terminal connection of the transmit current loop.
- Pos 5. +Reader Enable. This lead is the current loop positive reader control. When current is flowing, the reader is enabled.
- Pos 6. -Reader Enable. This lead is the negative terminal connection of the reader enable current loop.

Note: (Pos 5 and Pos 6) Reader Enable is not supplied on standard current loop Option T or H. The reader is always enabled. This feature allows the reader to be controlled (started/stopped) by the modem. If this feature is required, please consult the factory.

APPENDIX G

PARALLEL INPUT OPTION H, DB25S CONNECTOR (P17)

- Pins 1-8 Data Input 1-8. Channel 1-8. A logic "1" state on these inputs will cause a hole to be punched in the tape when a Punch Command at Pin 11 (described below) is initiated.
- Pin 11 Punch Command. A pulse input, switching from logic "0" state to logic "1" state which will initiate data capture and serial conversion if the conditions for Punch Ready (Pin 12) are met. The required duration of the pulse input is 100 microseconds.
- Pin 12 Punch Ready. A Logic "1" state output indicates the unit is ready to accept data, a Logic "0" state indicates the unit processing the data, and is not ready for additional data.
- Pins 20, 21 Error 1 and 2. These outputs are connected DC Ground.
- Pin 22 Unregulated +9V.
- Pin 24 +5V. This lead is a +5V output and should be limited to .1 Amp maximum.
- Pin 25 DC Ground. This lead serves as the voltage reference between interfacing devices.
- Pins 9, 10, 13- 19, 23. Unterminated.

Note: If OPTION H is installed with Option B, see Section 2.8.3 for operational details.

APPENDIX H

RS232 PRINTER OPTION E, DB25S CONNECTOR (P19)

-Pos 2. Data In. This lead is input to the NC-2400 but is inoperative.

-Pos 3. Data to Printer. This lead is the serial data output to a Serial Printer.

-Pins 5, 6. Clear to Send, Data Set Ready. These leads to the Printer are always held in the "ON" state.

-Pin 7. DC Ground. This lead serves as the voltage reference between the interfacing devices.

-Pin 8. Carrier Detect. This output to the Printer is always held in the "ON" state.

-Pin 11. Supervisory Send Data. This lead is an input to the unit that indicates the Printer is ready to operate and can accept data. When this lead is driven ON, the print function of the editor will transmit data, when driven OFF, data transmission is inhibited.

-Pin 1,4,9,10,11-25 Unterminated.

APPENDIX J

PARALLEL PRINTER OPTION E, DB25P CONNECTOR (J18)

-Pin 1 Data Strobe. This lead is a pulse output to the Printer indicating that there is a character to print.

-Pins 2-8 Data Bits 1-7. These leads contain the parallel data that should be printed.

-Pin 9 Data Bit 8. This lead is an output to the Printer and is always in the logic "0" state.

-Pin 10 Acknowledge. This lead is an input pulse to the unit from the Printer indicating that the Printer has received the character and is ready to accept another character.

-Pin 11 Busy. This lead is an input to the unit from the Printer indicating that the Printer is ready to receive data. A logic "0" state indicates that the Printer is ready to receive data, a logic "1" state means it is not able to receive data.

-Pin 13 Select. This lead is an input to the unit which when at a logic "1" state, indicates that the Printer is selected.

-Pin 16 DC Ground. This lead serves as the voltage reference between the interfaced devices.

_Pins 12, 14, 15, 17-25 Unterminated.

APPENDIX K

RS-491 INTERFACE, NC UNIT TO PUNCH

The recently published (Oct. 1982) EIA RS-491 Standard defines the interface between Numerical Control Units and peripheral equipment (punch/readers for example) having RS-423A electrical signal characteristics.

The Standard also specifies that the RS-491 protocol may be implemented on equipment with RS-232 electrical signal characteristics. This is the feature which is built into the NC-2400; i.e. can be selected by setting a DIP switch. Position 3 of DIP switch SW201 (see section 2.9) enables or disables the RS-491 Protocol on the modem and terminal RS-232 post. With this DIP switch in the RS-491 position, the NC-2400 will meet the RS-491 Level II Protocol requirements as "Responding Unit" as illustrated on the following page.

CROSS REFERENCE PIN NUMBERS RS449 (RS491) TO RS232

RS-449	For RS-449 Connector Pin No.	RS-232C	NC-2400 Modem DB25P Pin No.
Shield	1	Protective Ground	1
SD	4	Transmitted Data	2
RD	6	Received Data	3
RS	7	Request To Send	4
CS	9	Clear To Send	5
DM	11	Data Set Ready	
SG	19	Signal Ground	7
RR	13	Received Line Signal Detector (carrier detect)	
TR	12	Data Terminal Ready	20

RS-491
LEVEL II PROTOCOL

