

ADD Ready
 140 ns busy
 215 ns
 ← spaced in RAS → CAS delay

Rastin
 ← 300 ns →

RAS
 3ms
 10ms

CAS
 47 ns
 50 ns
 250 ns
 ~10ms
 47 ns interspersed

DATA READY

SET UP COMPLETE

HOLD DATA
 COMPUTER
 CYCLE

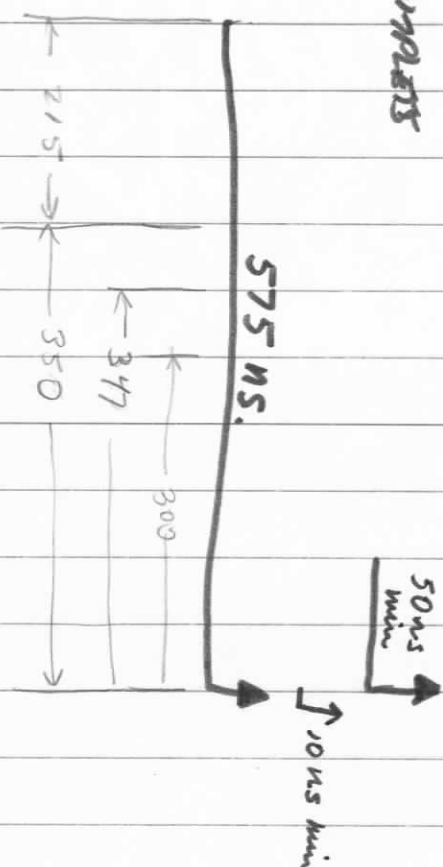

← 6502

← cal from phi 2

← cal from Rastin

← cal from RAS

← memory requirement

← 6502

← 1502

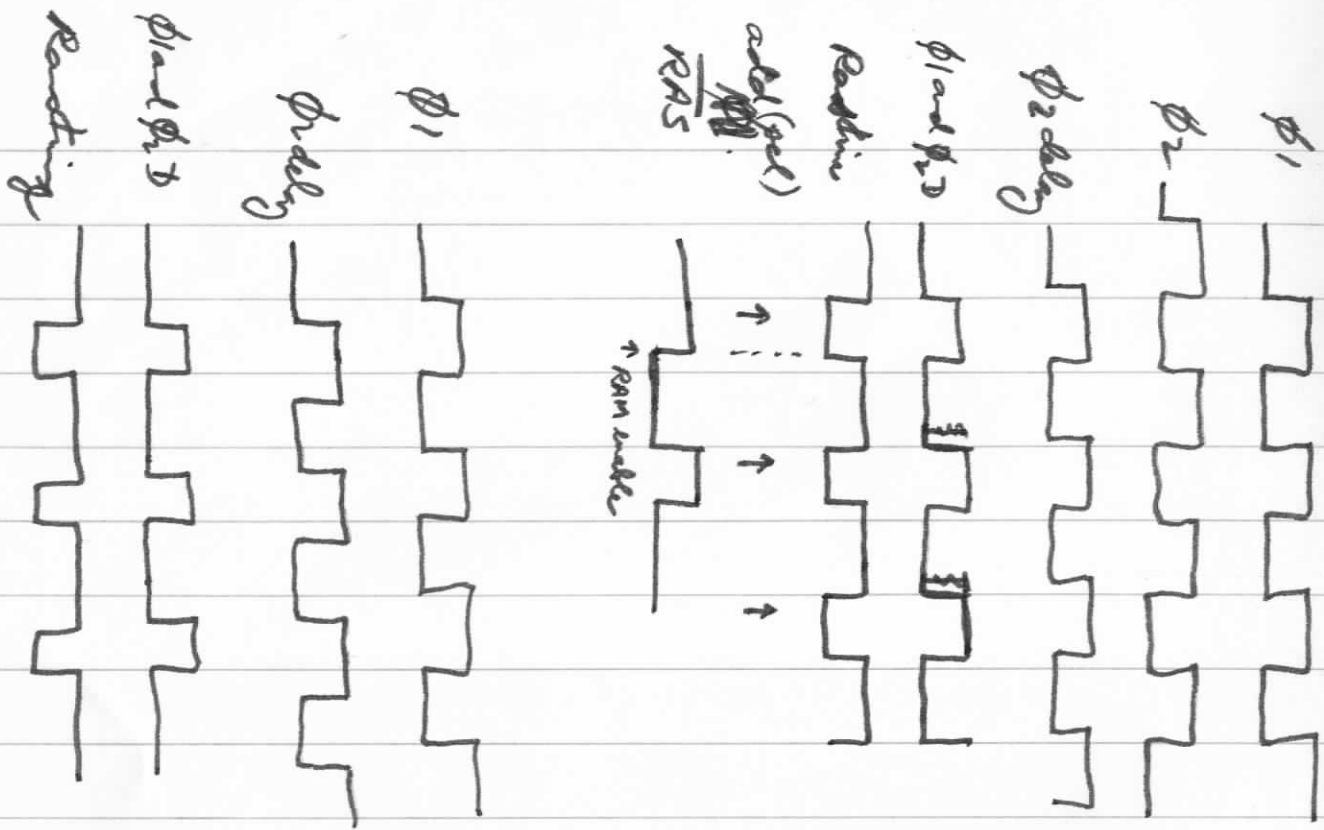

delay slightly less than $\frac{1}{2}$ cycle

delay slightly more than $\frac{1}{2}$ cycle

2.1MHz 6502 Timing

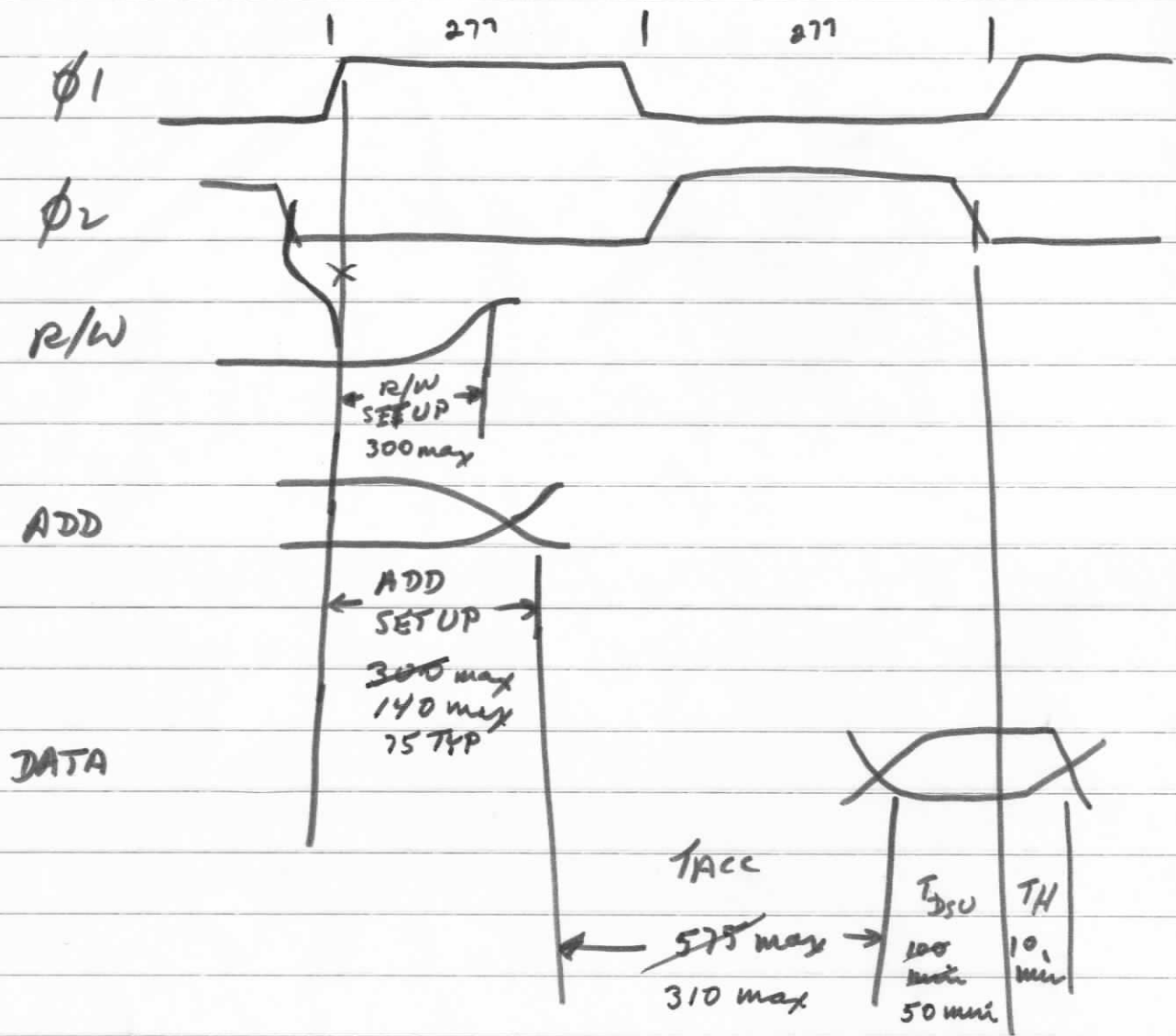

PART = 6502A
 1 TTL Load + 130 pf

Memory Timing

Access Times 150, 200, 250ns.

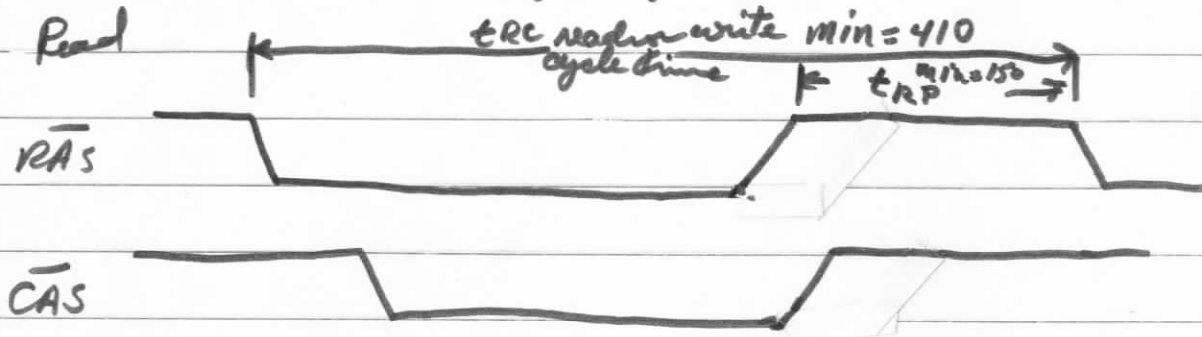

ADDRESS ROW COLUMN

DATA

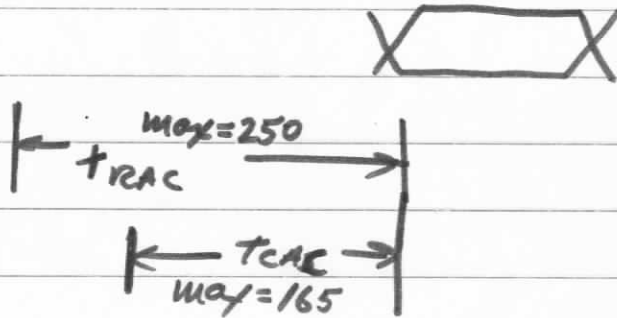

Component side

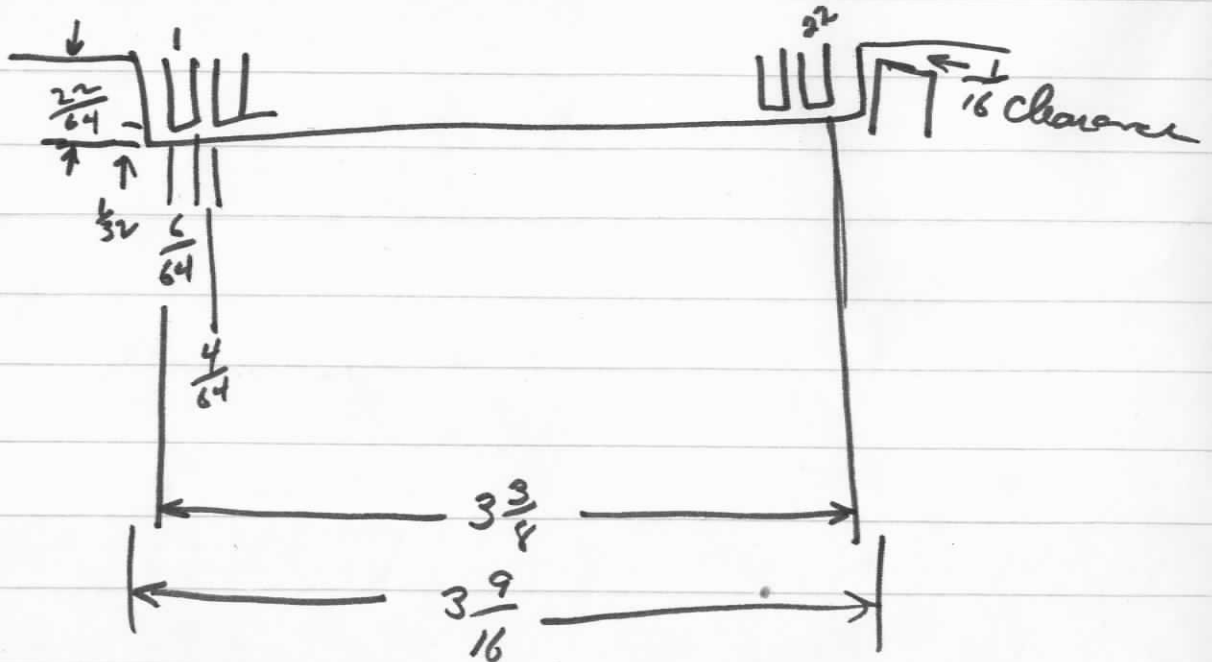

$\frac{5}{32}$
 $\frac{3}{16}$
 $\frac{21}{32}$
 $\frac{4}{16}$

- 065 → BOARD AT METAL
- 062 → BOARD ONLY

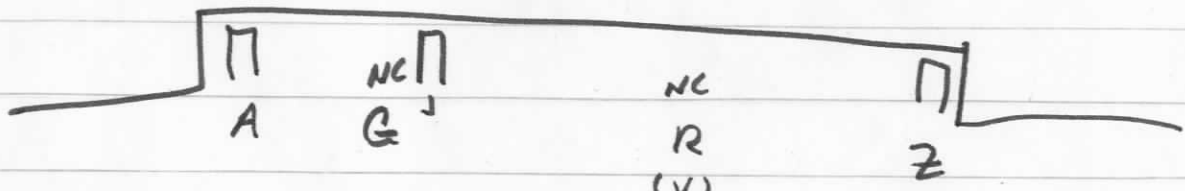

Back

ACTUAL

NC ↓
 ABCDEFGHJKLNPQRSTU VWXYZ
 NC ↓
 NC ↓

1 - 3 4 5 6 7 8 9 10 11 12 13 14 15 16 17 18 19 20 21 22
 ↑
 NC

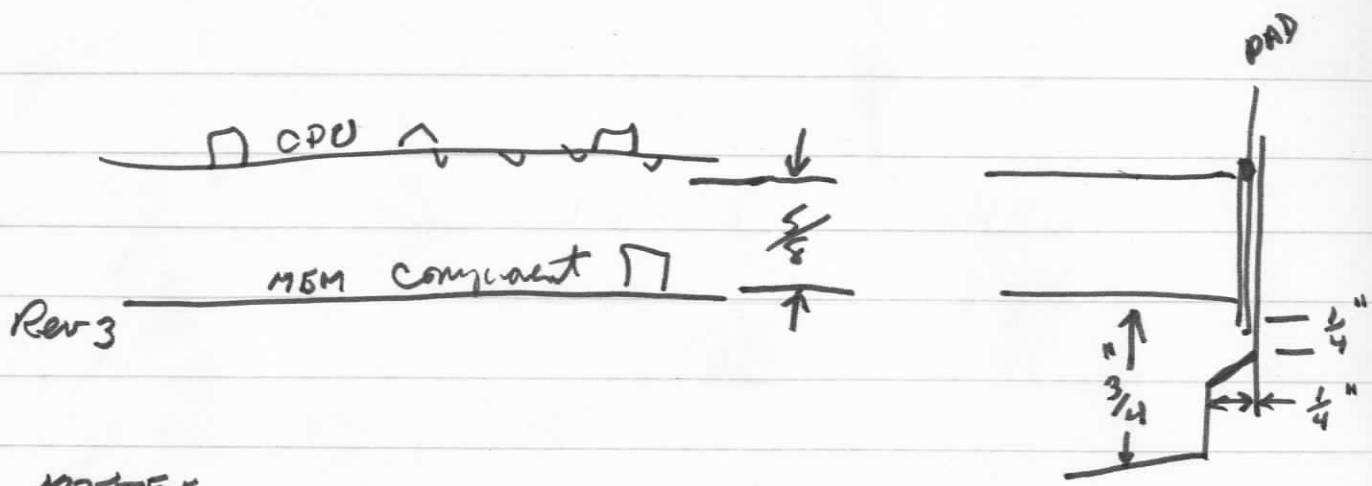

MOSTEK
 MK4108N-40

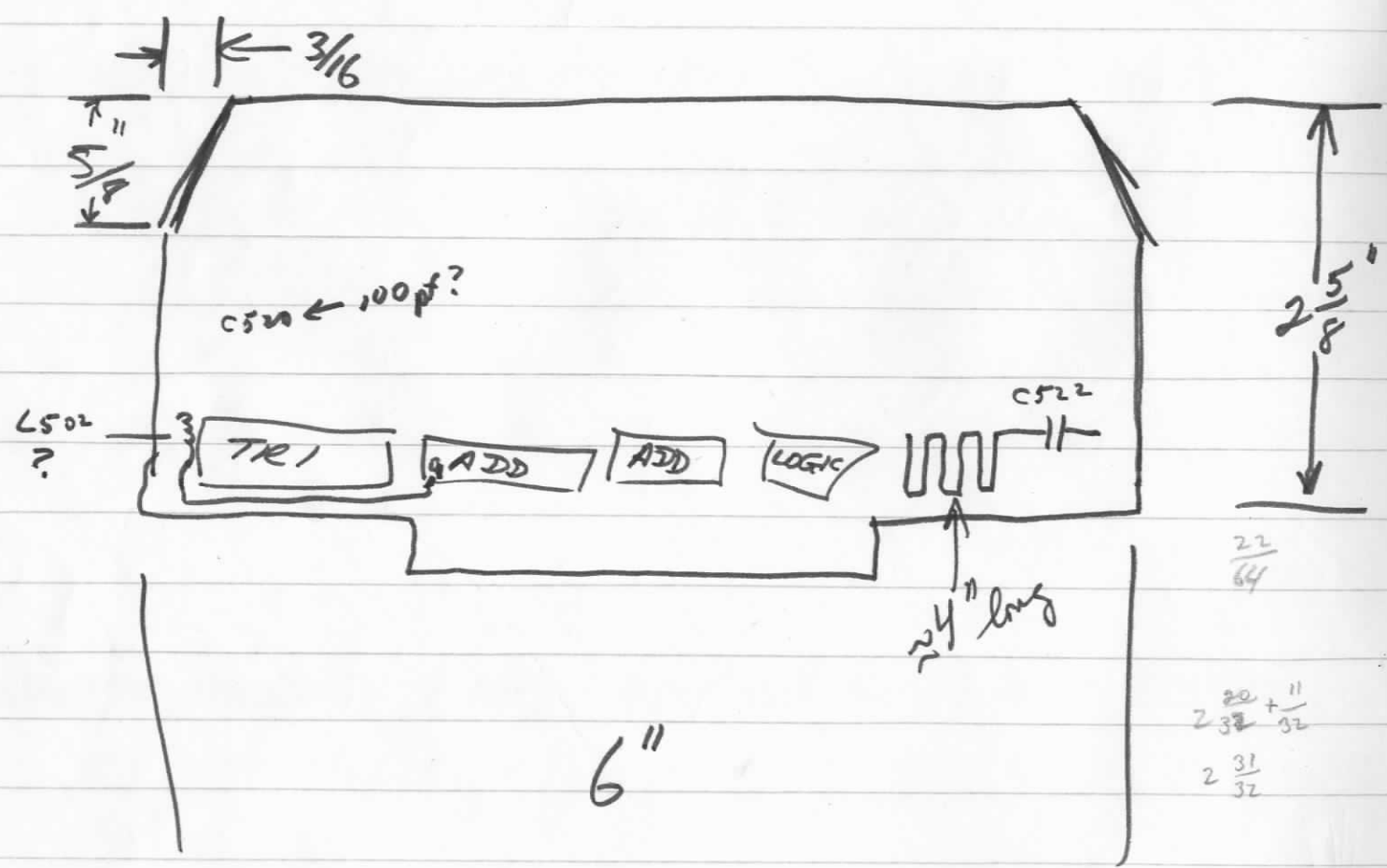

DR BLK RD BLK RD
 1 0 0 0
 RD VIO BLK GOLD BLK
 2 7 0 27pf.

		16K	8K
N		}	}
M			
R		}	
P	S3		
S	S2	}	
T			
U	S1		}

R/W Early	16	
R/W Late	13	
\overline{REF}	17	
\overline{SEL}	18	50
RASTIMB	15	

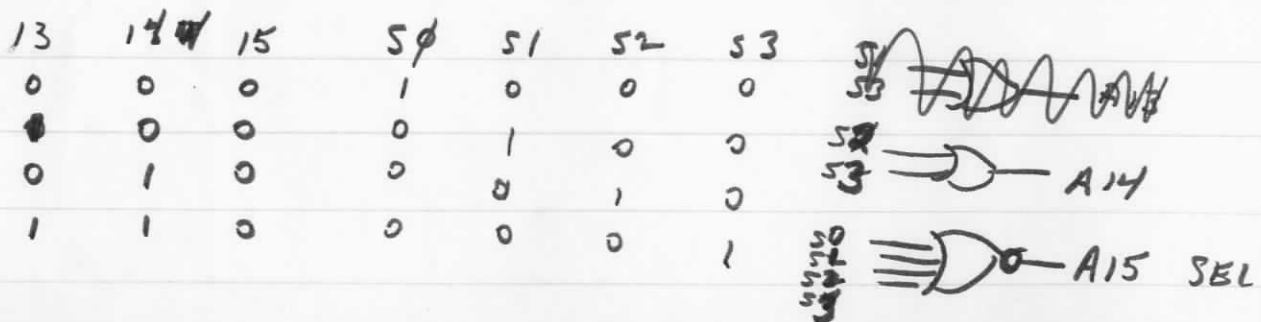
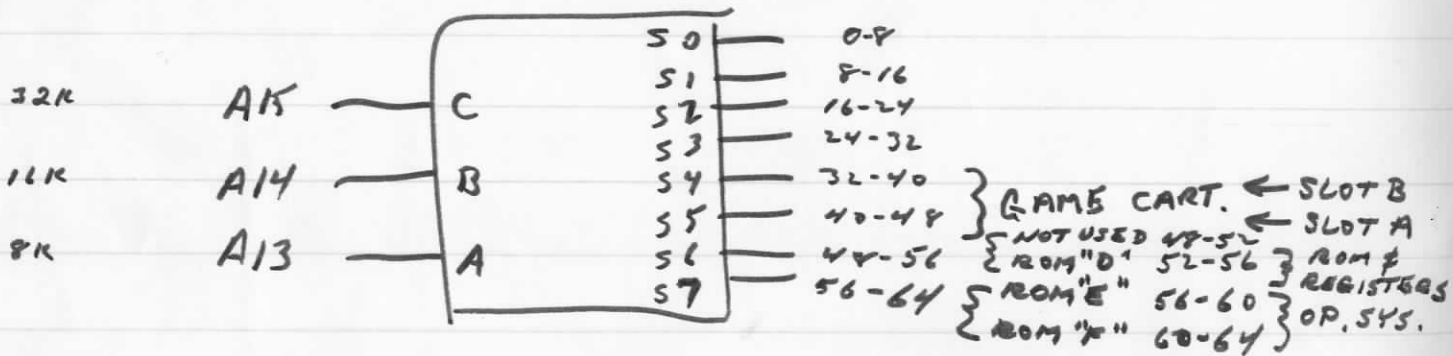

Memory Seg.

- 0-7 K
- 8-15 K
- 16-23 K
- 24-31 K
- 32-39 K
- 40-47 K
- 48-55 K
- 56-64 K

A13	A14	A15	S0	S1	S2	S3	S4	S5	'A14'	'A15'	new 'A15'
0	0	0	0	1	1	1	1	1	0	1	0
1	0	0	1	0	1	1	1	1	0	1	0
0	1	0	1	1	0	1	1	1	1	1	0
1	1	0	1	1	1	0	1	1	1	1	0
0	0	1	1	1	1	1	0	1	0	0	1
1	0	1	1	1	1	1	1	0	0	1	1
0	1	1	1	1	1	1	1	1	0	1	0
1	1	1	1	1	1	1	1	1	0	1	0

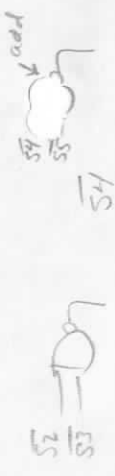

12/26/84

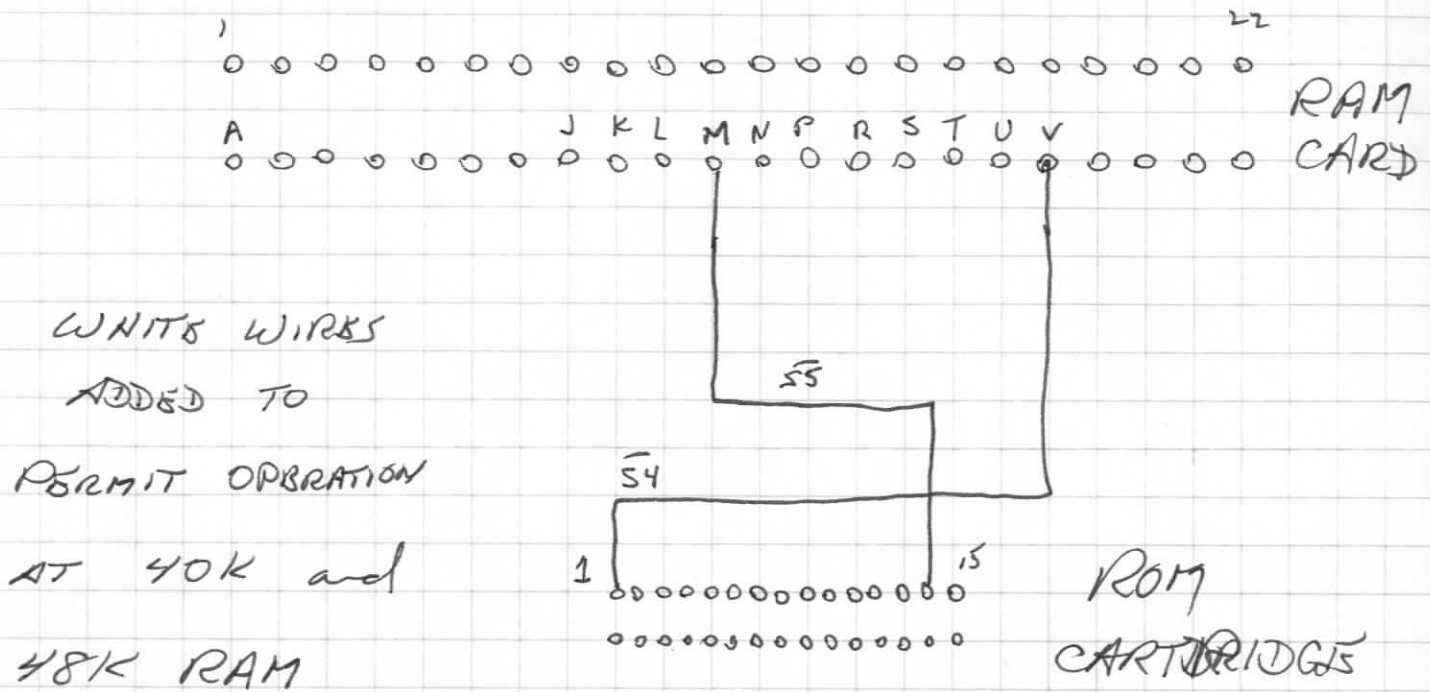

CONNECTION TO PIN V ~~WAS~~ ON RAM CARD WAS
REMOVED TO PERMIT USE OF NEW CARTRIDGES SUCH
AS "POLE POSITION" WHICH REQUIRES USE OF
40-48K and 32-40K ~~MEMORY~~ ALLOCATIONS.

THEREFORE, ONLY 32K RAM IS NOW AVAILABLE.

IF ADDER RAM IS REQUIRED, INTERLOCK SCHEM~~E~~S WITH
CARTRIDGES IS REQUIRED. PROBABLY PIN A CAN

BE OF HELP (THIS PIN IS CONNECTED FOR 16K CARTRIDGES
BUT NOT 8K CARTRIDGES. ALSO TO GO TO 48K WILL
NEED SHORTING CARD.

DON'T USE

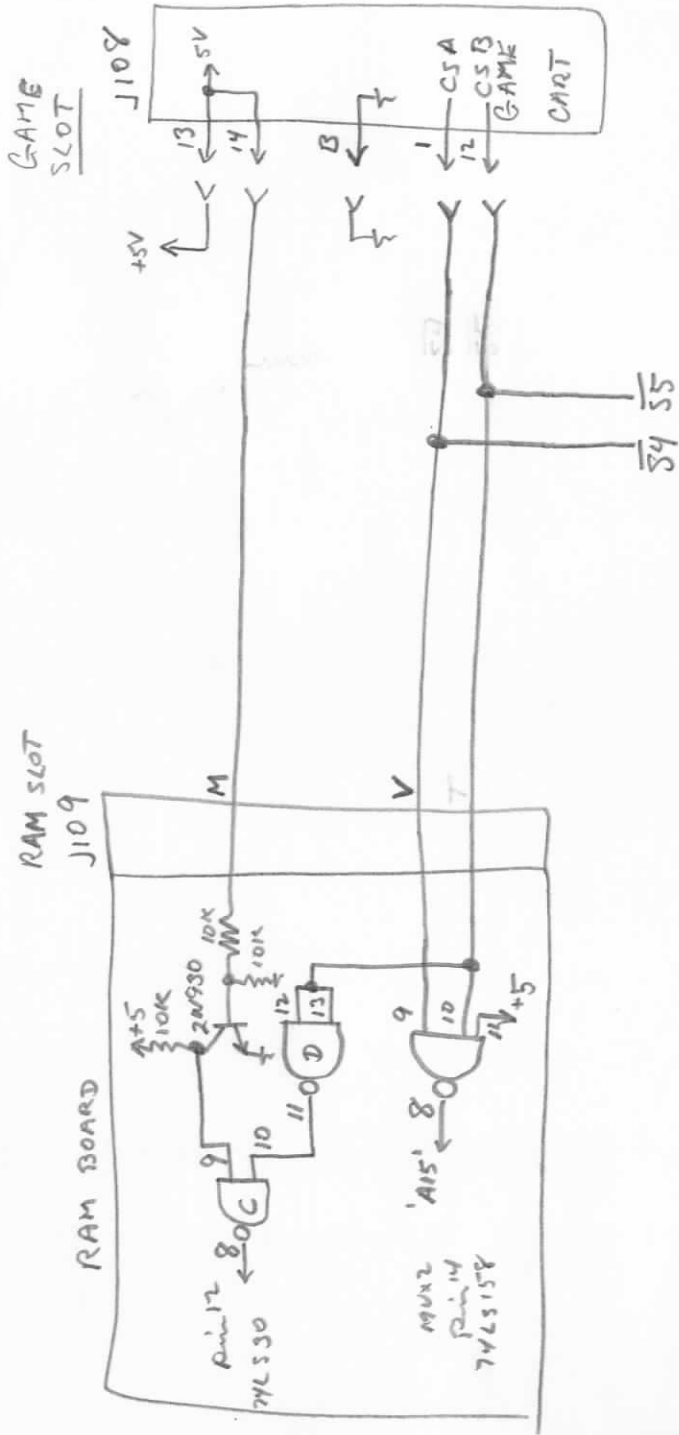

PREFER THIS APPROACH

require this jumper
to get 48K

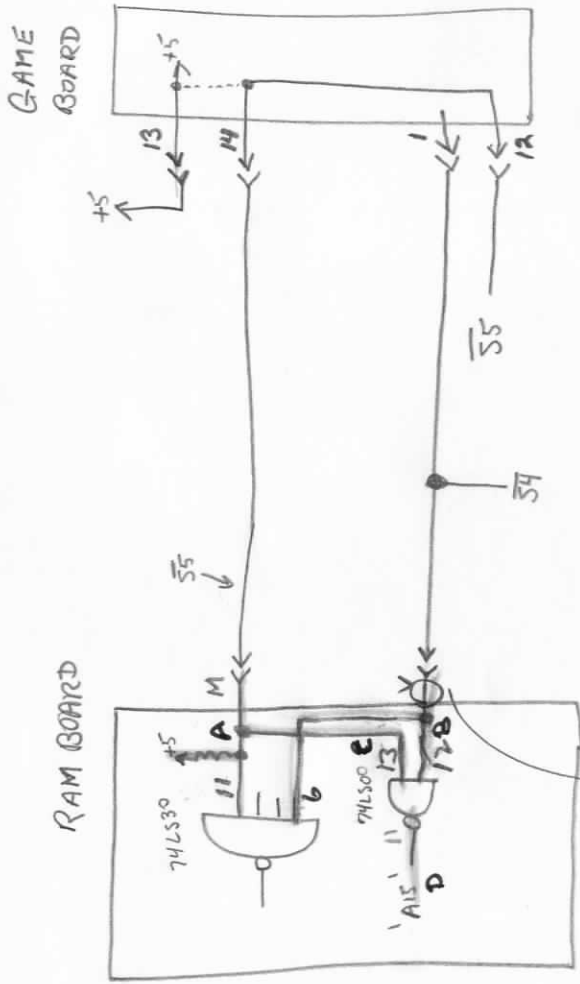

INSERT OPTIONS

- ① GAME BOARD - disabled 55 RAM 40K
- ② NO BOARD - disabled 55 RAM 40K
- ③ JUMPER BOARD - enabled 55 RAM 48K

12	00	13	15
00	00	00	00
00	00	00	00
AB	00	00	00

THIS CONNECTION

REMOVES 12/26/84 TO PERMIT USE OF 16K CARTRIDGES

Z Y X W V U P N M L K J H F E D C B A
TSR

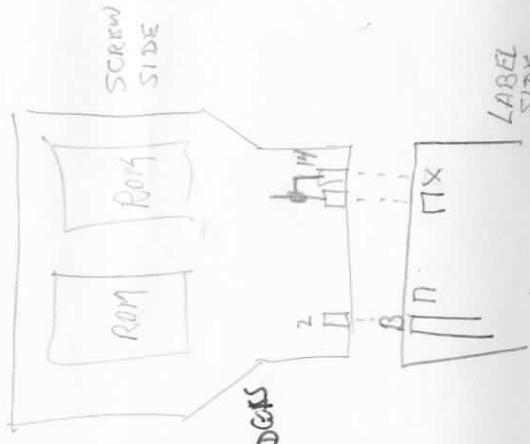

Check your 8K RAM board to be sure that V and M are not used

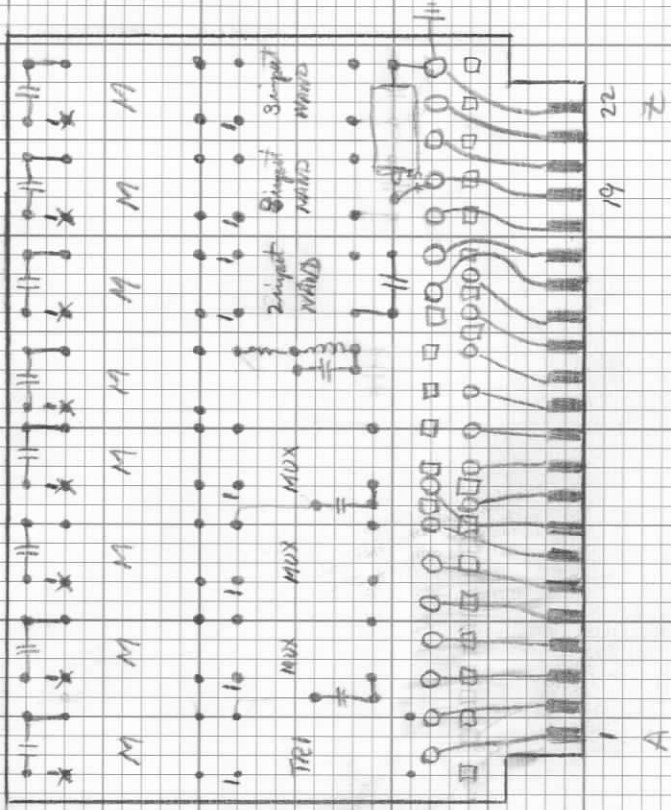

74LS158 +5

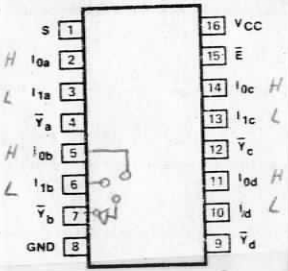

A8 → 0
A0 → 1

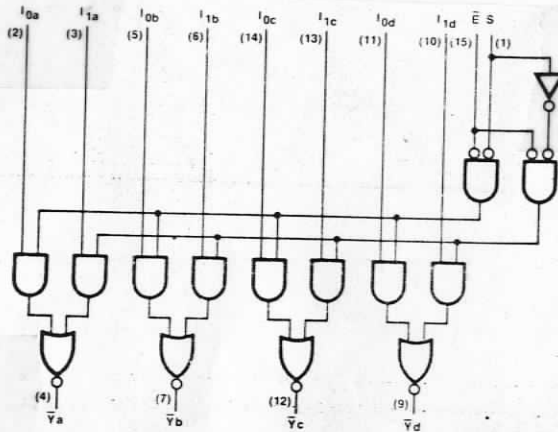

TRUTH TABLE

ENABLE	SELECT INPUT	DATA INPUTS		OUTPUTS
\bar{E}	S	I ₀	I ₁	\bar{Y}
H	X	X	X	H
L	L	L	X	H
L	L	H	X	L
L	H	X	L	H
L	H	X	H	L

74LS244

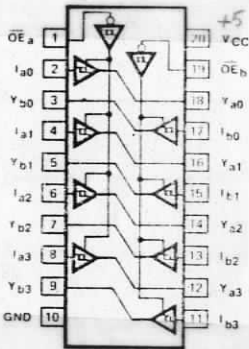

MCM6665

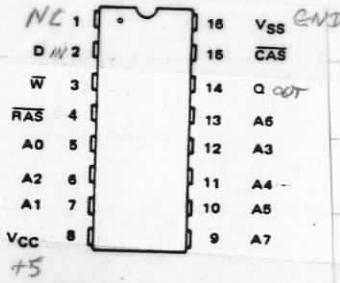

74LS00

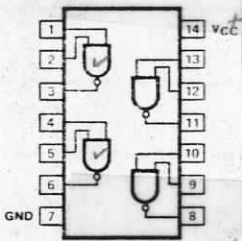

74LS10

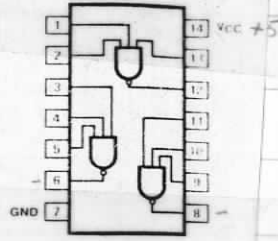

74LS30

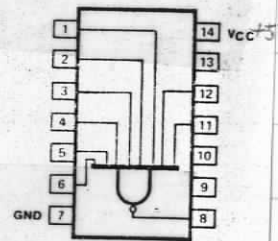

64K BYTE DYNAMIC RAM
 (WIRED FOR 98K)
 FOR ATARI 400 RIB / 22567782

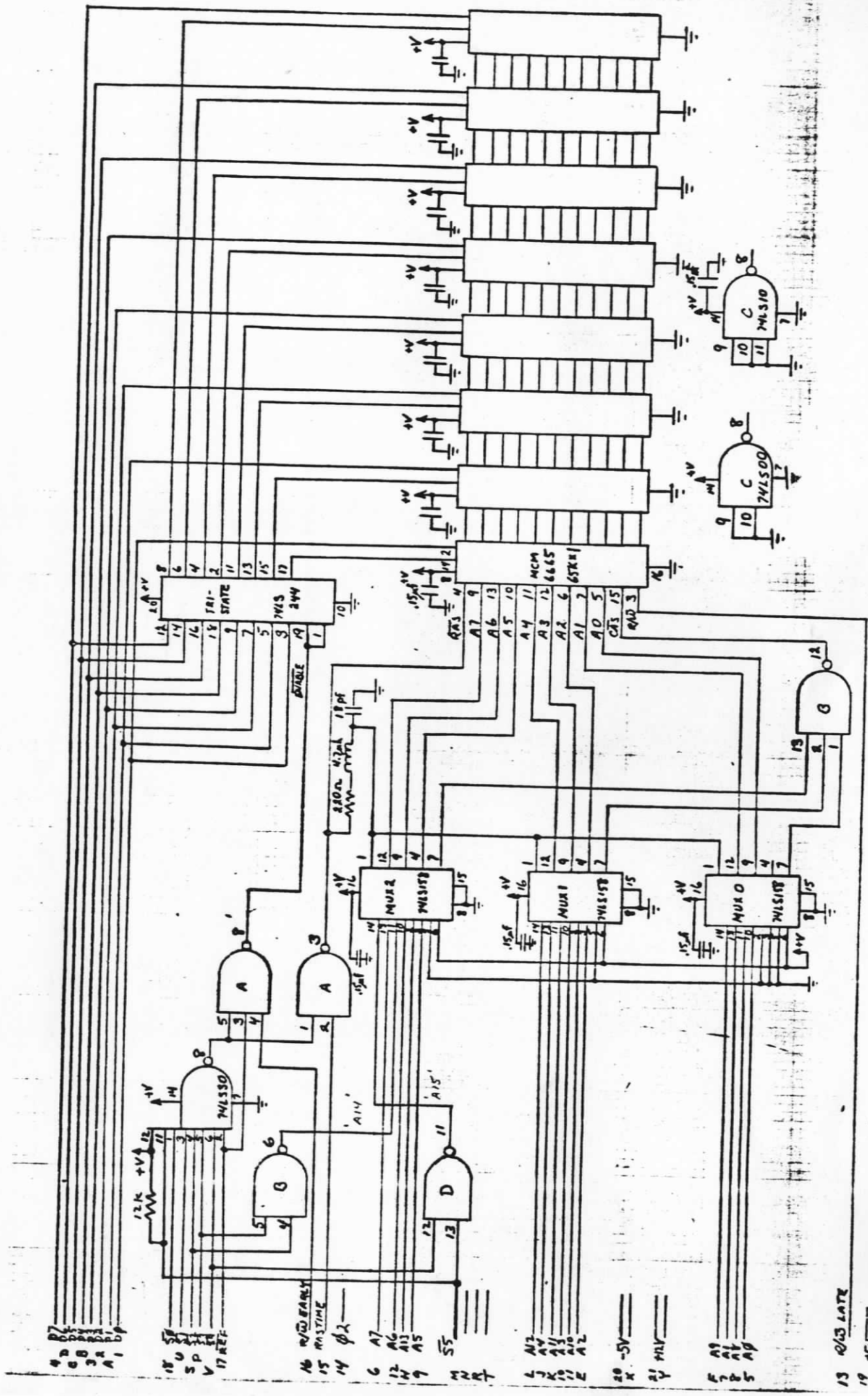

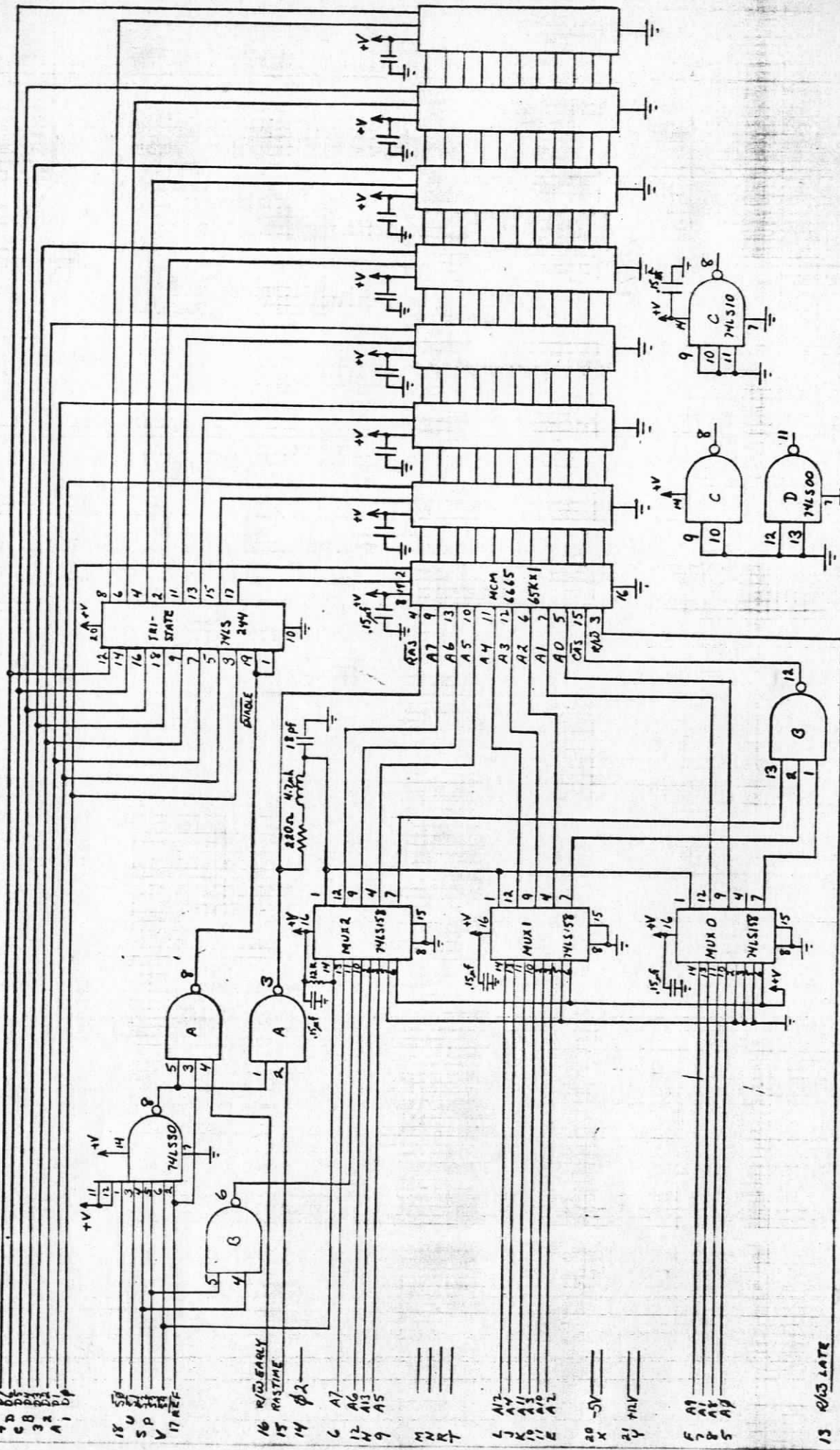

64K BYTE DYNAMIC RAM
 (WIRED FOR 32K)
 FOR ATARI 400 RHB / SIMRBL

- 4 DZ
- 5 BZ
- 6 CZ
- 7 DZ
- 8 EZ
- 9 FZ
- 10 GZ
- 11 HZ
- 12 IZ
- 13 JZ
- 14 KZ
- 15 LZ
- 16 MZ
- 17 NZ
- 18 OZ
- 19 PZ
- 20 QZ
- 21 RZ
- 22 SZ
- 23 TZ
- 24 UZ
- 25 VZ
- 26 WZ
- 27 XZ
- 28 YZ
- 29 ZZ
- 30
- 31
- 32
- 33
- 34
- 35
- 36
- 37
- 38
- 39
- 40
- 41
- 42
- 43
- 44
- 45
- 46
- 47
- 48
- 49
- 50
- 51
- 52
- 53
- 54
- 55
- 56
- 57
- 58
- 59
- 60
- 61
- 62
- 63
- 64
- 65
- 66
- 67
- 68
- 69
- 70
- 71
- 72
- 73
- 74
- 75
- 76
- 77
- 78
- 79
- 80
- 81
- 82
- 83
- 84
- 85
- 86
- 87
- 88
- 89
- 90
- 91
- 92
- 93
- 94
- 95
- 96
- 97
- 98
- 99
- 100

